



DUAL BAND Mobile SGH-N100

by Toko (www.gsm-free.com)

SERVICE *Manual*

DUAL BAND Mobile Cellular Phone



CONTENTS

1. Exploded Views and Parts List
2. PCB Diagrams
3. Electrical Parts List
4. Block Diagrams
5. Flow chart of trouble shooting

1. Exploded Views and Parts List

- 1-1 Main
- 1-2 Main Parts List
- 1-3 Travel Adapter
- 1-4 Travel Adapter Parts List
- 1-5 Ciger Light Adapter
- 1-6 Ciger Light Adapter Parts List
- 1-7 Hands Free Kit
- 1-8 Test Zig
- 1-9 Earphone
- 1-10 Data Kit
- 1-11 Desk Top Charger

2. PCB Diagrams

- 2-1 Main Top
- 2-1 Main Bottom

3. Electrical Parts List

- 3-1 Main Parts List Top
- 3-2 Main Parts List Bottom

4. Block Diagrams

- 4-1 Main Base Band
- 4-2 Main RF

5. Flow chart of trouble shooting

- 5-1 Power ON
 - 5-2 Initial
 - 5-3 Charging Part
 - 5-4 Sim Part
 - 5-5 Microphone Part
 - 5-6 Speaker Part
 - 5-7 Key Data Input
 - 5-8 Alert tone
 - 5-9 Ring Indicator
 - 5-10 Back Light
 - 5-11 GSM Receiver
 - 5-12 GSM Transmit
 - 5-13 DCS Receiver
 - 5-14 DCS Transmit
-

1. Exploded Views and Parts List

1-1 Main

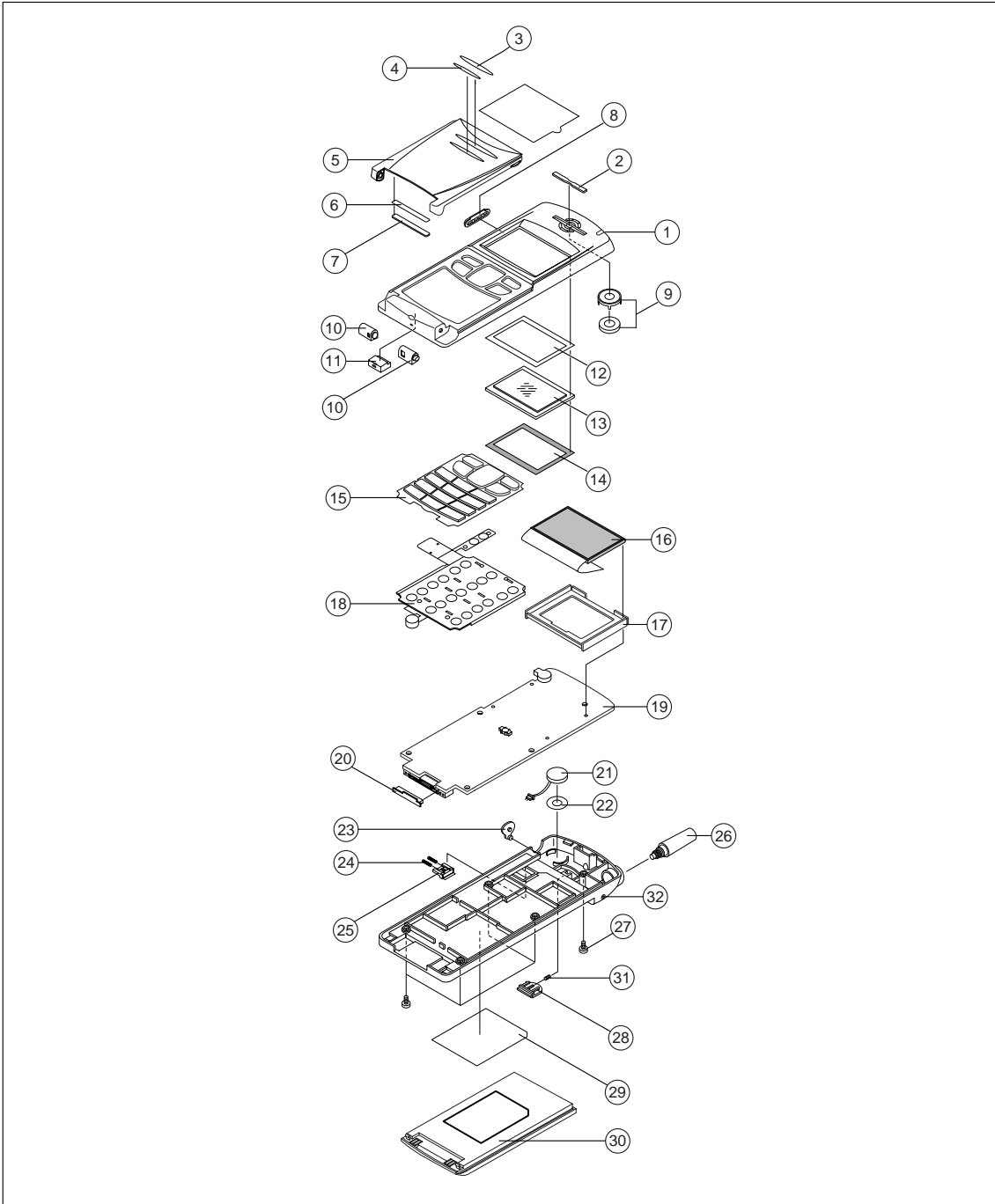

1-2 Main Parts List

NO	PARTS NAME	PARTS NO	COLOR	Q'TY	REMARK
1	FRONT COVER	GH72-00462A	DARK GARY	1	
		GH72-00462B	SILVER	1	
		GH72-00462C	SKY BLUT	1	
		GH72-00462D	GREEN	1	
		GH72-00462E	DEEP BLUE	1	
2	EARPIECE DECORATION	GH72-01674A		1	
3	DECORATION A	GH72-01530A		1	
4	DECORATION B	GH72-01531A		1	
5	FLIP COVER	GH72-01529A	DARK GARY	1	
		GH72-01529B	SILVER	1	
		GH72-01529C	SKY BLUE	1	
		GH72-01529D	GREEN	1	
		GH72-01529E	DEEP BLUE	1	
6	MACNET	GH70-00079A		1	
7	MACNET SHEET	GH74-00687A	DARK GARY	1	
		GH74-00687B	SILVER	1	
		GH74-00687C	SKY BLUE	1	
		GH74-00687D	GREEN	1	
8	SIDE KEY ASS'Y	GH75-00672A		1	
9	SPEAKER UNIT	GH96-00908A		1	
10	HINCE ASS'Y	GH75-00287A		2	
11	MIC HOLDER	GH73-00145A		1	
12	WINDOW TAPE	GH74-00230A		1	
13	LCD WINDOW	GH72-01532A		1	
14	WINDOW SPONGE	GH74-00684A		1	
15	3x4 KEY ASS'Y	GH75-00686A	DARK GARY	1	
		GH75-00686B		1	
		GH75-00686C		1	
16	LCD	GH96-00937A		1	
17	LCD BRACKET ASS'Y	GH75-00429A		1	
18	KEY PCB	GH96-00936A		1	
19	MAIN PCB	GH92-00818A		1	
20	I/F CONNECTOR COVER	GH73-40639A	DARK GARY	1	
		GH73-40639B	SILVER	1	
		GH73-40639C	SKY BLUE	1	
		GH73-40639D	GREEN	1	

NO	PARTS NAME	PARTS NO	COLOR	Q'TY	REMARK
21	VIBRATOR	GH31-00019A		1	
22	VIBRATOR TAPE	GH74-00466A		1	
23	COVER EARPHONE	GH73-00148A	DARK GRAY	1	
		GH73-00148B	SILVER	1	
		GH73-00148C	SKY BLUE	1	
		GH73-00148D	GREEN	1	
24	SIM LOCKER SPRING	GH61-00011A		2	
25	SIM KNOB ASS'Y	GH75-00725A	DARK GARY	1	
		GH75-00725B	SILVER	1	
		GH75-00725C	SKY BLUE	1	
		GH75-00725D	GREEN	1	
		GH75-00725E	DEEP BLUE	1	
26	ANTENA	GH42-00058A	DARK GRAY	1	
		GH42-00058B	SILVER	1	
		GH42-00058C	SKY BLUE	1	
		GH42-00058D	GREEN	1	
27	SCREW	6001-001346		5	
28	LOCKER MAIN	GH72-01535A	DARK GRAY	1	
		GH72-01535B	SILVER	1	
		GH72-01535C	SKY BLUE	1	
		GH72-01535D	GREEN	1	
		GH72-01535E	DEEP BLUE	1	
29	LABEL MAIN	GH68-01392A		1	
30	BATTERY STANDARD	GH43-00260A	DARK GRAY	1	
		GH43-00260B	SILVER	1	
		GH43-00260C	SKY BLUE	1	
		GH43-00260D	GREEN	1	
		GH43-00260E	DEEP BLUE	1	
31	MAIN LOCKER SPRING	GH61-00009A		1	
32	REAR COVER	GH72-01533A	DARK GRAY	1	
		GH72-01533B	SILVER	1	
		GH72-01533C	SKY BLUE	1	
		GH72-01533D	GREEN	1	
		GH72-01533E	DEEP BLUE	1	

1-3 Travel Adapter

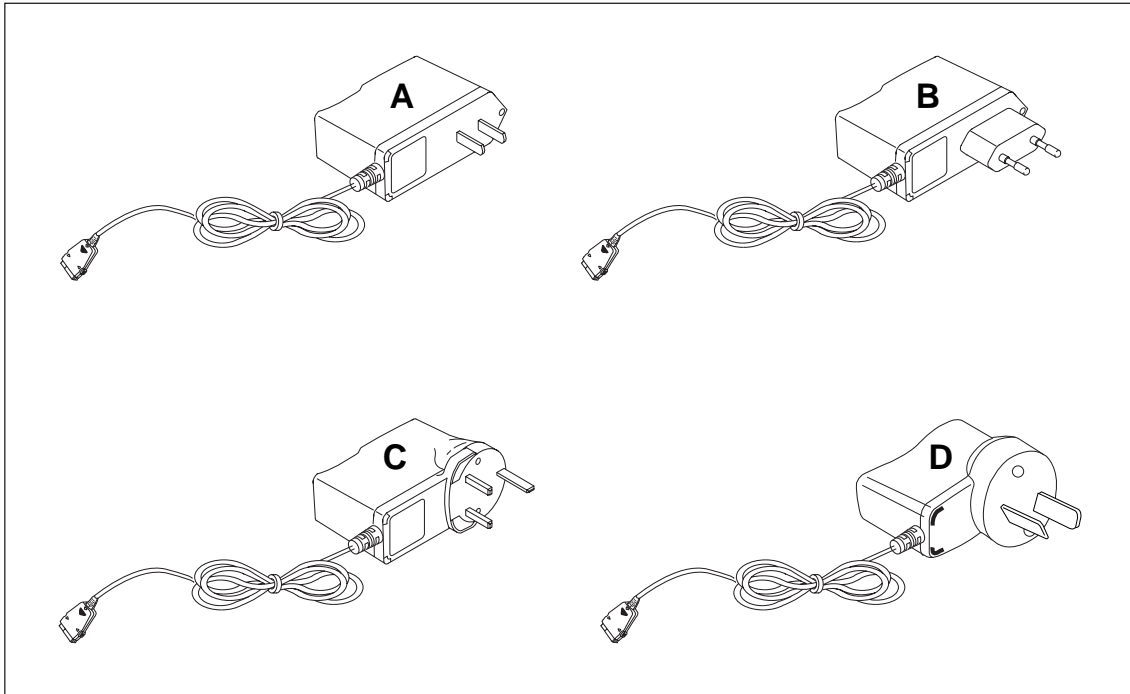

1-4 Travel Adapter Parts List

TYPE	SEC CODE	REMARK
A	GH44-00119C	CHINA
B	GH44-00119A	EUROPE
C	GH44-00119B	UNITED KINGDOM
D	Gh44-00119D	AUSTRALIA

1-5 Ciger Light Adapter

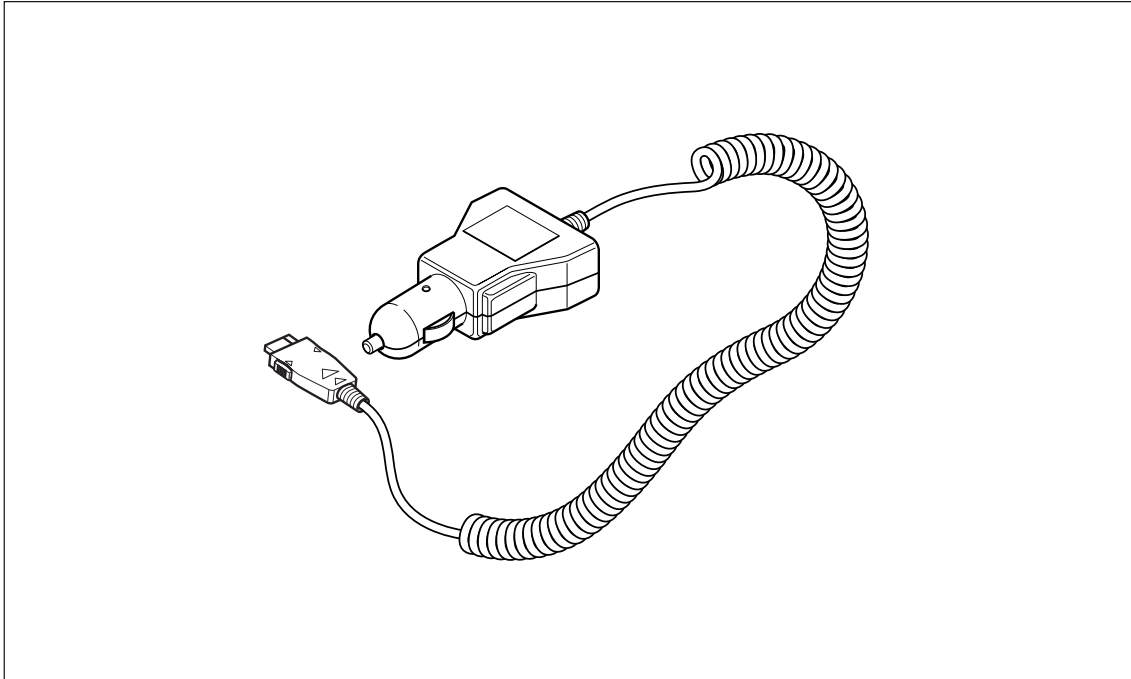

1-6 Ciger Light Adapter Parts List

DESCRIPTION	SEC CODE	REMARK
Ciger Light Adapter Code	GH44-00040A	BLACK

1-7 Hands Free Kit

SEC CODE : GH96-00941A

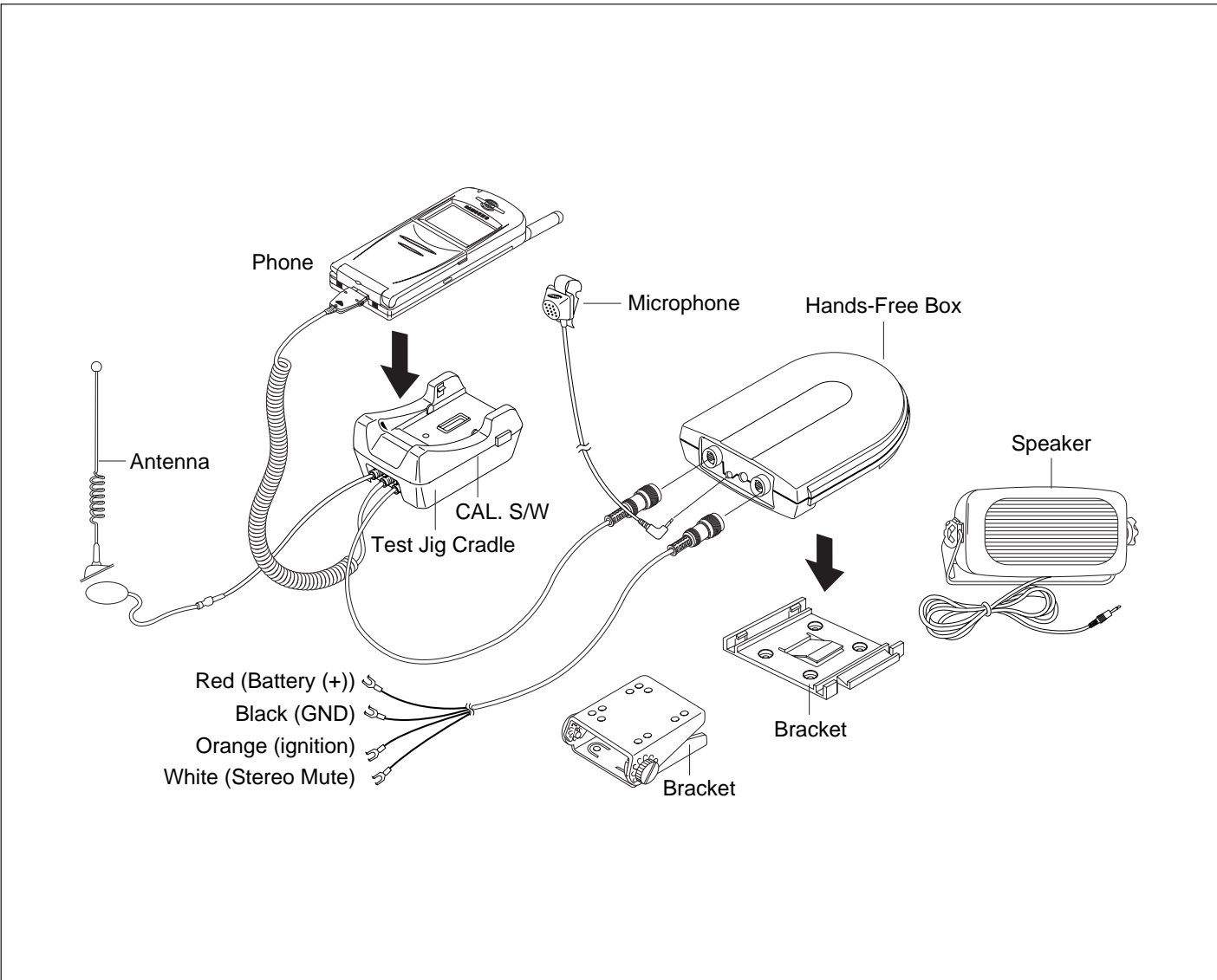

1-8 Test Zig

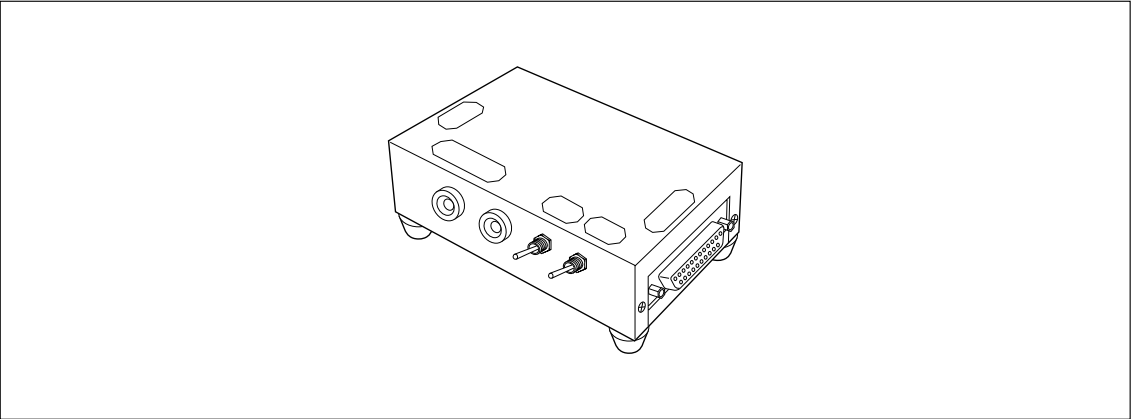

TEST JIG

GH80-10508A

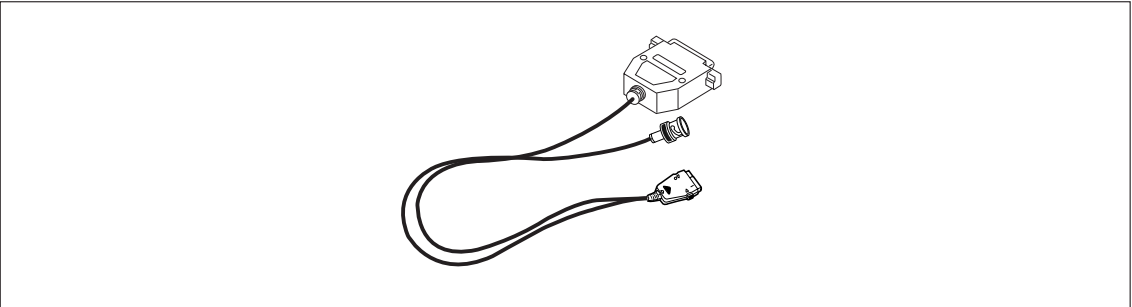

TEST JIG CABLE

GH39-30532A

1-9 Earphone

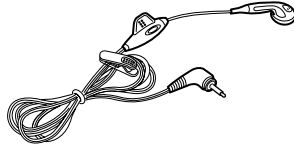

EARPHONE

GH96-00830A

1-10 Data Kit

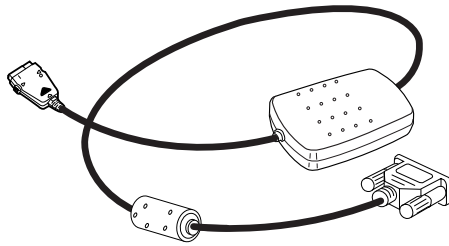

DATA KIT

GH39-30533A

1-11 Desk Top Charger

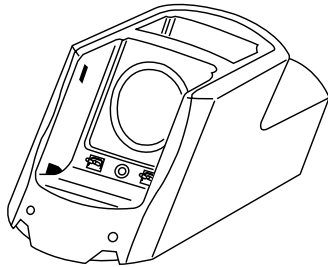

DESK TOP CHARGER

GH44-00163A

2. PCB Diagrams

2-1 Main Top

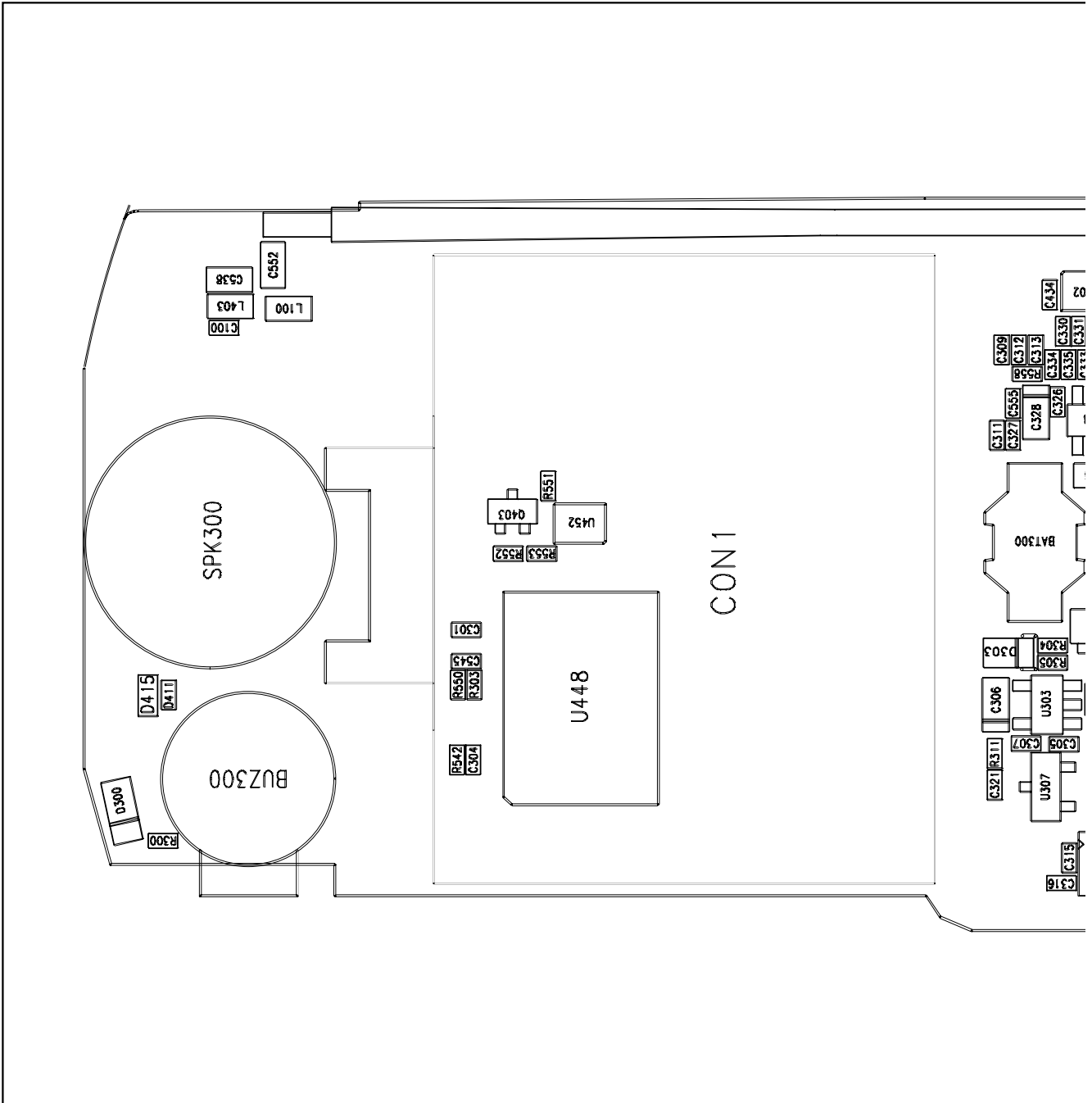

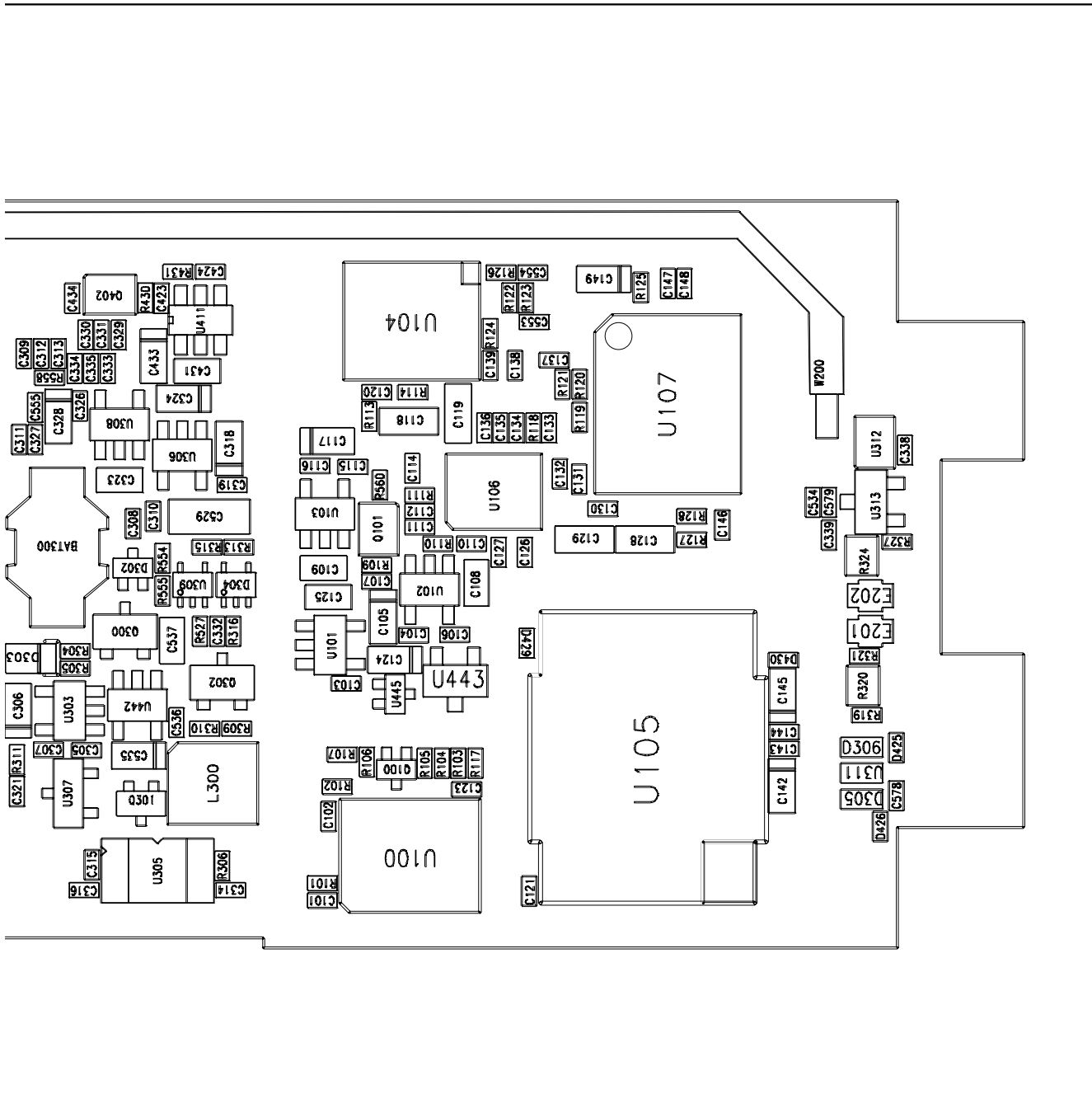

2-1 Main Bottom

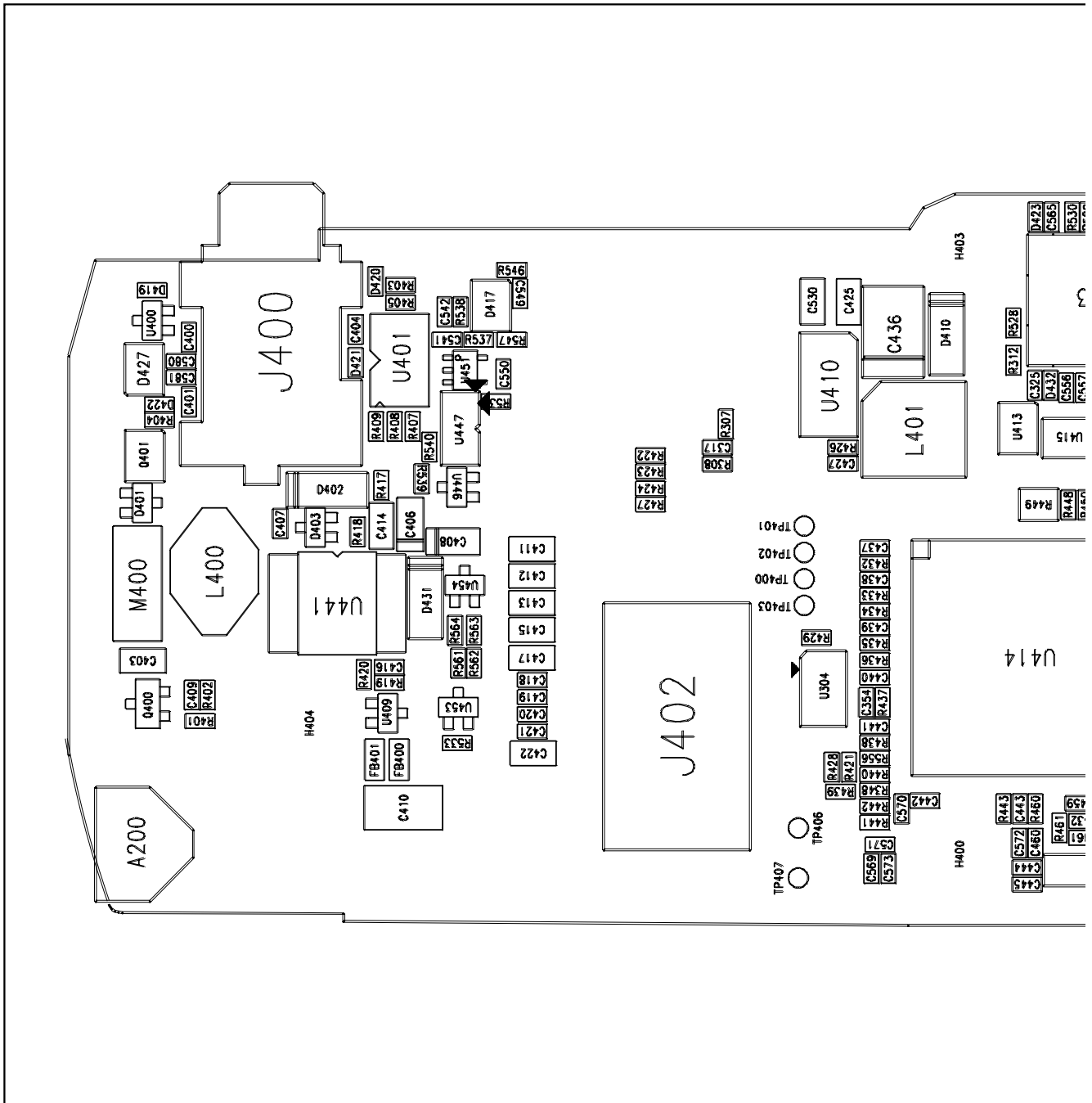

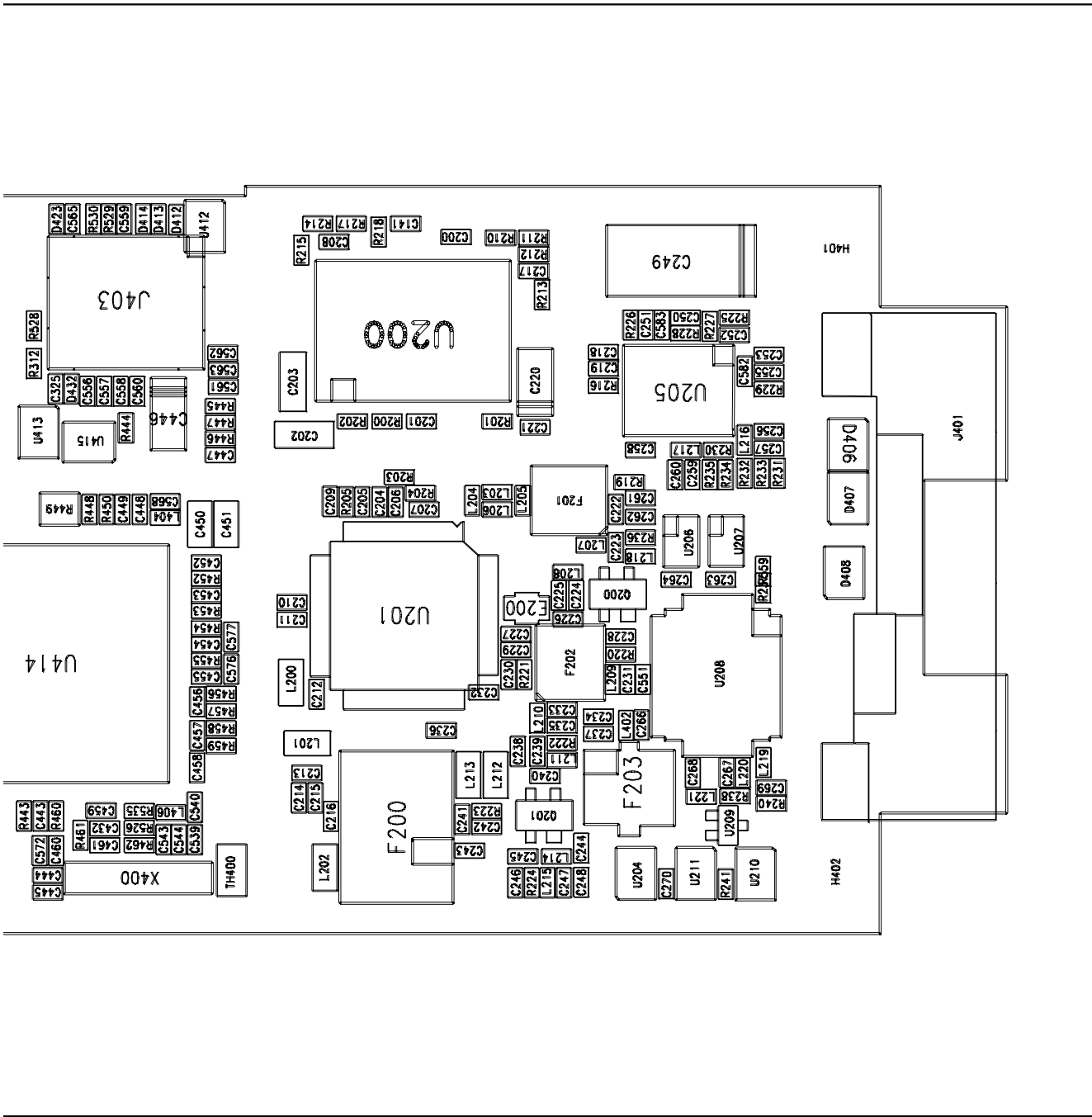

3. Electrical Parts List

3-1 Main Parts List Bottom

NO	Reference	SEC CODE	Part Description	Vendor Part No.
1	BAT300	3710-001668	BACKUP BATTERY HOLDER	BH-2A-4.8D-2.0
2	BUZ300	3002-001098	BUZZER-SMD	BRT-03S
3	C100	2203-000466	C-CHIP, 1pF, 0.25pF, 50V, TP, 1005	GRM36C0G010C50PT
4	C101	2203-000254	C-CHIP, 10nF, 10%, 16V, TP, 1005	GRM36X7R103K25PT
5	C102	2203-000254	C-CHIP, 10nF, 10%, 16V, TP, 1005	GRM36X7R103K25PT
6	C105	2404-001105	CAP-TANTAL, 10uF, 20%, 6.3V, 2012	TESVSPQJ106M8R
7	C106	2203-005061	C-CHIP, 100nF, +80-20%, 16V, TP, 1005	GRM36Y5V104Z16PT
8	C107	2203-005061	C-CHIP, 100nF, +80-20%, 16V, TP, 1005	GRM36Y5V104Z16PT
9	C108	2203-005065	C-CHIP, 1uF, +80-20%, 10V, TP, 1608	GRM39Y5V105Z10PT
10	C109	2203-005065	C-CHIP, 1uF, +80-20%, 10V, TP, 1608	GRM39Y5V105Z10PT
11	C110	2203-005061	C-CHIP, 100nF, +80-20%, 16V, TP, 1005	GRM36Y5V104Z16PT
12	C111	2203-005061	C-CHIP, 100nF, +80-20%, 16V, TP, 1005	GRM36Y5V104Z16PT
13	C112	2203-005061	C-CHIP, 100nF, +80-20%, 16V, TP, 1005	GRM36Y5V104Z16PT
14	C114	2203-005061	C-CHIP, 100nF, +80-20%, 16V, TP, 1005	GRM36Y5V104Z16PT
15	C116	2203-005061	C-CHIP, 100nF, +80-20%, 16V, TP, 1005	GRM36Y5V104Z16PT
16	C117	2404-001105	CAP-TANTAL, 10uF, 20%, 6.3V, 2012	TESVSPQJ106M8R
17	C118	2301-001230	C-FILM, 10nF, 5%, 16V, TP, 2012	ECHU1C103JB5
18	C119	2301-001350	C-FILM, 1.5nF, 5%, 16V, TP, 2012	ECHU1C152JB5
19	C120	2203-002525	C-CHIP, 560pF, 10%, 50V, TP, 1005	GRM36X7R561K50PT
20	C121	2203-000995	C-CHIP, 47pF, 10%, 50V, TP, 1005	GRM36COG470C50PT
21	C123	2203-000254	C-CHIP, 10nF, 10%, 16V, TP, 1005	GRM36X7R103K25PT
22	C124	2404-001105	CAP-TANTAL, 10uF, 20%, 6.3V, 2012	TESVSPQJ106M8R
23	C125	2203-005065	C-CHIP, 1uF, +80-20%, 10V, TP, 1608	GRM39Y5V105Z10PT
24	C126	2203-000438	C-CHIP, 1nF, 10%, 50V, TP, 1005	GRM36X7R102K50PT
25	C127	2203-000233	C-CHIP, 100pF, 5%, 50V, TP, 1005	GRM36COG101J50PT
26	C128	2301-001230	C-FILM, 10nF, 5%, 16V, TP, 2012	ECHU1C103JB5
27	C129	2301-001231	C-FILM, 680pF, 5%, 50V, TP, 2012	ECHU1H681JB5
28	C130	2203-000679	C-CHIP, 27pF, 5%, 50V, TP, 1005	GRM36COG270J50PT
29	C131	2203-000425	C-CHIP, 18pF, 5%, 50V, TP, 1005	GRM36COG180J50PT
30	C132	2203-000233	C-CHIP, 100pF, 5%, 50V, TP, 1005	GRM36COG101J50PT
31	C133	2203-000233	C-CHIP, 100pF, 5%, 50V, TP, 1005	GRM36COG101J50PT
32	C134	2203-000233	C-CHIP, 100pF, 5%, 50V, TP, 1005	GRM36COG101J50PT
33	C135	2203-000233	C-CHIP, 100pF, 5%, 50V, TP, 1005	GRM36COG101J50PT
34	C136	2203-000438	C-CHIP, 1nF, 10%, 50V, TP, 1005	GRM36X7R102K50PT
35	C137	2203-000812	C-CHIP, 33pF, 5%, 50V, TP, 1005	GRM36COG330J50PT
36	C138	2203-000233	C-CHIP, 100pF, 5%, 50V, TP, 1005	GRM36COG101J50PT
37	C139	2203-000438	C-CHIP, 1nF, 10%, 50V, TP, 1005	GRM36X7R102K50PT
38	C142	2404-001105	CAP-TANTAL, 10uF, 20%, 6.3V, 2012	TESVSPQJ106M8R

NO	Reference	SEC CODE	Part Description	Vendor Part No.
39	C143	2203-000812	C-CHIP, 33pF, 5%, 50V, TP, 1005	GRM36COG330J50PT
40	C145	2404-001105	CAP-TANTAL, 10uF, 20%, 6.3V, 2012	TESVSPOJ106M8R
41	C146	2203-000233	C-CHIP, 100pF, 5%, 50V, TP, 1005	GRM36COG101J50PT
42	C147	2203-000254	C-CHIP, 10nF, 10%, 16V, TP, 1005	GRM36X7R103K25PT
43	C148	2203-000679	C-CHIP, 27pF, 5%, 50V, TP, 1005	GRM36COG270J50PT
44	C149	2404-001105	CAP-TANTAL, 10uF, 20%, 6.3V, 2012	TESVSPOJ106M8R
45	C301	2203-005061	C-CHIP, 100nF, +80-20%, 16V, TP, 1005	GRM36Y5V104Z16PT
46	C304	2203-000254	C-CHIP, 10nF, 10%, 16V, TP, 1005	GRM36X7R103K25PT
47	C305	2203-000233	C-CHIP, 100pF, 5%, 50V, TP, 1005	GRM36COG101J50PT
48	C306	2404-001105	CAP-TANTAL, 10uF, 20%, 6.3V, 2012	TESVSPOJ106M8R
49	C307	2203-000254	C-CHIP, 10nF, 10%, 16V, TP, 1005	GRM36X7R103K25PT
50	C308	2203-005061	C-CHIP, 100nF, +80-20%, 16V, TP, 1005	GRM36Y5V104Z16PT
51	C309	2203-000254	C-CHIP, 10nF, 10%, 16V, TP, 1005	GRM36X7R103K25PT
52	C310	2203-000812	C-CHIP, 33pF, 5%, 50V, TP, 1005	GRM36COG330J50PT
53	C311	2203-000812	C-CHIP, 33pF, 5%, 50V, TP, 1005	GRM36COG330J50PT
54	C312	2203-000812	C-CHIP, 33pF, 5%, 50V, TP, 1005	GRM36COG330J50PT
55	C313	2203-000254	C-CHIP, 10nF, 10%, 16V, TP, 1005	GRM36X7R103K25PT
56	C314	2203-000254	C-CHIP, 10nF, 10%, 16V, TP, 1005	GRM36X7R103K25PT
57	C315	2203-001101	C-CHIP, 6.8nF, 10%, 25V, X7R, TP, 1005	GRM36X7R682K25PT
58	C316	2203-005061	C-CHIP, 100nF, +80-20%, 16V, TP, 1005	GRM36Y5V104Z16PT
59	C318	2404-001105	CAP-TANTAL, 10uF, 20%, 6.3V, 2012	TESVSPOJ106M8R
60	C319	2203-000254	C-CHIP, 10nF, 10%, 16V, TP, 1005	GRM36X7R103K25PT
61	C323	2203-005065	C-CHIP, 1uF, +80-20%, 10V, TP, 1608	GRM39Y5V105Z10PT
62	C324	2404-001105	CAP-TANTAL, 10uF, 20%, 6.3V, 2012	TESVSPOJ106M8R
63	C326	2203-000254	C-CHIP, 10nF, 10%, 16V, TP, 1005	GRM36X7R103K25PT
64	C327	2203-000812	C-CHIP, 33pF, 5%, 50V, TP, 1005	GRM36COG330J50PT
65	C328	2404-001105	CAP-TANTAL, 10uF, 20%, 6.3V, 2012	TESVSPOJ106M8R
66	C329	2203-003054	C-CHIP, 9pF, 0.5pF, 50V, TP, 1005	GRM36COG090D50PT
67	C330	2203-000812	C-CHIP, 33pF, 5%, 50V, TP, 1005	GRM36COG330J50PT
68	C331	2203-000254	C-CHIP, 10nF, 10%, 16V, TP, 1005	GRM36X7R103K25PT
69	C332	2203-005061	C-CHIP, 100nF, +80-20%, 16V, TP, 1005	GRM36Y5V104Z16PT
70	C333	2203-000254	C-CHIP, 10nF, 10%, 16V, TP, 1005	GRM36X7R103K25PT
71	C334	2203-000254	C-CHIP, 10nF, 10%, 16V, TP, 1005	GRM36X7R103K25PT
72	C335	2203-000254	C-CHIP, 10nF, 10%, 16V, TP, 1005	GRM36X7R103K25PT
73	C338	2203-002443	C-CHIP, 330pF, 10%, 50V, X7R, TP, 1005	GRM36X7R331K50PT
74	C339	2203-005061	C-CHIP, 100nF, +80-20%, 16V, TP, 1005	GRM36Y5V104Z16PT
75	C431	2203-005065	C-CHIP, 1uF, +80-20%, 10V, TP, 1608	GRM39Y5V105Z10PT
76	C434	2203-000254	C-CHIP, 10nF, 10%, 16V, TP, 1005	GRM36X7R103K25PT
77	C529	2203-005562	C-CHIP, 10uF, +80-20%, 10V, 3216	GRM230Y5V106Z10PT
78	C534	2203-005061	C-CHIP, 100nF, +80-20%, 16V, TP, 1005	GRM36Y5V104Z16PT
79	C535	2404-001105	CAP-TANTAL, 10uF, 20%, 6.3V, 2012	TESVSPOJ106M8R
80	C536	2203-000254	C-CHIP, 10nF, 10%, 16V, TP, 1005	GRM36X7R103K25PT

NO	Reference	SEC CODE	Part Description	Vendor Part No.
81	C537	2203-005065	C-CHIP, 1uF, +80-20%, 10V, TP, 1608	GRM39Y5V105Z10PT
82	C538	2203-000697	C-CHIP, 2pF, 0.25pF, 50V, TP, 1608	GRM39COG020C50PT
83	C545	2203-005061	C-CHIP, 100nF, +80-20%, 16V, TP, 1005	GRM36Y5V104Z16PT
84	C522	2203-000872	C-CHIP, 3pf, 1608	CLIOCL30CBNC
85	C554	2203-000278	C-CHIP, 10pF, 5%, 50V, TP, 1005	GRM36COG050C50PT
86	C555	2203-000679	C-CHIP, 27pF, 5%, 50V, TP, 1005	GRM36COG270J50PT
87	C578	2203-000679	C-CHIP, 27pF, 5%, 50V, TP, 1005	GRM36COG270J50PT
88	C579	2203-000679	C-CHIP, 27pF, 5%, 50V, TP, 1005	GRM36COG270J50PT
89	D300	0601-000276	LED, CHIP, Y/GRN, 1.6x2.0mm	CL-150YG-CD-T
90	D302	0407-001002	DIODE-ARRAY, 80V, 300mA, CA2-3, EM3	DAN222
91	D303	0401-001033	DIODE-SWITCHING, 25V,200mA,M-MELF,TP	MCL4154
92	D304	0407-001007	DIODE-ARRAY, 80V, 25mA, CA4-2, UM5	UMN1
93	D305	1405-001018	Zener Diode, 14V, 1.6x0.8mm, TP	VC060314A300
94	D306	1405-001019	Zener Diode, 5.6V, 1.6x0.8mm, TP	VC060305A150
95	D411	1405-001082	VARISTOR, 5.6V,20A,1x0.5x0.6mm,TP	VC040205X150
96	D415	1405-001019	Zener Diode, 5.6V, 1.6x0.8mm, TP	VC060305A150
97	D425	1405-001082	VARISTOR, 5.6V,20A,1x0.5x0.6mm,TP	VC040205X150
98	D426	1405-001082	VARISTOR, 5.6V,20A,1x0.5x0.6mm,TP	VC040205X150
99	D429	1405-001082	VARISTOR, 5.6V,20A,1x0.5x0.6mm,TP	VC040205X150
100	D430	1405-001082	VARISTOR, 5.6V,20A,1x0.5x0.6mm,TP	VC040205X150
101	E201	2901-001116	FILTER-EMI, 50V, 300mA, 470pF, 2x1.25x0.5	NFM39R12C471T1M
102	E202	2901-001116	FILTER-EMI, 50V, 300mA, 470pF, 2x1.25x0.5	NFM39R12C471T1M
103	L100	2703-001791	Inductor, 15nH, 5%, 1.8x1.12x1.02mm	0603CS-15NXJBC
104	L300	2703-002052	Inductor 1.5mH	BDS-3516-152M
105	L403	2703-001166	Inductor, 5.6nH, 5%, 1608	ELJRE5N6JF2
106	Q100	0501-000225	TR-SMALL SIGNAL, NPN, 200mW, EM3, TP	2SC4617R
107	Q101	0505-001423	FET-SILICON, FDG6323L,N/P,0.3W,SC70-6	FDG6323L
108	Q300	0501-002011	TR-SMALL SIGNAL, NPN, 200mW, SOT-23	2SD2114KT146
109	Q301	0501-000162	TR-SMALL SIGNAL, PNP, 200mW, SOT-323, TP	2SA1576A-R-T106
110	Q302	0501-002011	TR-SMALL SIGNAL, NPN, 200mW, SOT-23	2SD2114KT146
111	Q402	0505-001423	FET-SILICON, FDG6323L,N/P,0.3W,SC70-6	FDG6323L
112	Q403	0501-000162	TR-SMALL SIGNAL, PNP, 200mW, SOT-323, TP	2SA1576A-R-T106
113	R101	2007-000148	R-CHIP, 10Kohm, 5%, 1/16W, DA, TP, 1005	RC1005J103CS
114	R102	2007-000172	R-CHIP, 10ohm, 5%, 1/16W, DA, TP, 1005	RC1005J100CS
115	R103	2007-000141	R-CHIP, 2.2Kohm, 5%, 1/16W, DA, TP, 1005	ERJ2GEJ222X
116	R104	2007-000155	R-CHIP, 27Kohm, 5%, 1/16W, DA, TP, 1005	ERJ2GEJ273X
117	R105	2007-001244	R-CHIP, 91Kohm, 5%, 1/16W, DA, TP, 1005	ERJ2GEJ913X
118	R106	2007-000140	R-CHIP, 1Kohm, 5%, 1/16W, DA, TP, 1005	ERJ2GEJ102X
119	R107	2007-001307	R-CHIP, 180ohm, 5%, 1/16W, DA, TP, 1005	ERJ2GEJ181
120	R109	2007-000148	R-CHIP, 10Kohm, 5%, 1/16W, DA, TP, 1005	RC1005J103CS
121	R110	2007-000172	R-CHIP, 10ohm, 5%, 1/16W, DA, TP, 1005	RC1005J100CS
122	R111	2007-000172	R-CHIP, 10ohm, 5%, 1/16W, DA, TP, 1005	RC1005J100CS

NO	Reference	SEC CODE	Part Description	Vendor Part No.
123	R113	2007-001323	R-CHIP, 3Kohm, 5%, 1/16W, DA, TP, 1005	ERJ2GEJ302X
124	R114	2007-000141	R-CHIP, 2.2Kohm, 5%, 1/16W, DA, TP, 1005	ERJ2GEJ222X
125	R117	2007-000140	R-CHIP, 1Kohm, 5%, 1/16W, DA, TP, 1005	ERJ2GEJ102X
126	R118	2007-000242	R-CHIP, 1.5ohm, 5%, 1/16w, TP, 1005	ERJ2GEJ152X
127	R119	2007-001288	R-CHIP, 18ohm, 5%, 1/16W, DA, TP, 1005	ERJ2GEJ180
128	R120	2007-001288	R-CHIP, 18ohm, 5%, 1/16W, DA, TP, 1005	ERJ2GEJ180
129	R121	2007-001288	R-CHIP, 18ohm, 5%, 1/16W, DA, TP, 1005	ERJ2GEJ180
130	R122	2007-001288	R-CHIP, 18ohm, 5%, 1/16W, DA, TP, 1005	ERJ2GEJ180
131	R123	2007-001288	R-CHIP, 18ohm, 5%, 1/16W, DA, TP, 1005	ERJ2GEJ180
132	R124	2007-000172	R-CHIP, 10ohm, 5%, 1/16W, DA, TP, 1005	RC1005J100CS
133	R125	2007-000172	R-CHIP, 10ohm, 5%, 1/16W, DA, TP, 1005	RC1005J100CS
134	R126	2007-001288	R-CHIP, 18ohm, 5%, 1/16W, DA, TP, 1005	ERJ2GEJ180
135	R127	2007-007001	R-CHIP, 3.9Kohm, 5%, 1/16W, DA, TP, 1005	ERJ2GEJ392X
136	R128	2007-000148	R-CHIP, 10Kohm, 5%, 1/16W, DA, TP, 1005	RC1005J103CS
137	R300	2007-000139	R-CHIP, 220ohm, 5%, 1/16W, DA, TP, 1005	ERJ2GE221X
138	R303	2007-000148	R-CHIP, 10Kohm, 5%, 1/16W, DA, TP, 1005	RC1005J103CS
139	R304	2007-000162	R-CHIP, 100Kohm, 5%, 1/16W, DA, TP, 1005	RC1005J104CS
140	R305	2007-000143	R-CHIP, 4.7Kohm, 5%, 1/16W, DA, TP, 1005	RC1005J472CS
141	R306	2007-000140	R-CHIP, 1Kohm, 5%, 1/16W, DA, TP, 1005	ERJ2GEJ102X
142	R309	2007-000162	R-CHIP, 100Kohm, 5%, 1/16W, DA, TP, 1005	RC1005J104CS
143	R310	2007-000140	R-CHIP, 1Kohm, 5%, 1/16W, DA, TP, 1005	ERJ2GEJ102X
144	R311	2007-007771	R-CHIP, 0ohm, 5%, 1/16W, DA, TP, 1005	RC1005J000CS
145	R313	2007-000148	R-CHIP, 10Kohm, 5%, 1/16W, DA, TP, 1005	RC1005J103CS
146	R315	2007-000148	R-CHIP, 10Kohm, 5%, 1/16W, DA, TP, 1005	RC1005J103CS
147	R316	2007-000162	R-CHIP, 100Kohm, 5%, 1/16W, DA, TP, 1005	RC1005J104CS
148	R319	2007-007771	R-CHIP, 0ohm, 5%, 1/16W, DA, TP, 1005	RC1005J000CS
149	R320	2011-001344	R-NETWORK, 100ohm,5%,1/16W,L,CHIP,8P,TP	EXB28V101JX
150	R321	2007-000138	R-CHIP, 100ohm, 5%, 1/16W, DA, TP, 1005	ERJ2GEJ101X
151	R324	2011-001344	R-NETWORK, 100ohm,5%,1/16W,L,CHIP,8P,TP	EXB28V101JX
152	R327	2007-000143	R-CHIP, 4.7Kohm, 5%, 1/16W, DA, TP, 1005	RC1005J472CS
153	R430	2007-000148	R-CHIP, 10Kohm, 5%, 1/16W, DA, TP, 1005	RC1005J103CS
154	R431	2007-007771	R-CHIP, 0ohm, 5%, 1/16W, DA, TP, 1005	RC1005J000CS
155	R527	2007-000148	R-CHIP, 10Kohm, 5%, 1/16W, DA, TP, 1005	RC1005J103CS
156	R542	2007-000148	R-CHIP, 10Kohm, 5%, 1/16W, DA, TP, 1005	RC1005J103CS
157	R550	2007-000148	R-CHIP, 10Kohm, 5%, 1/16W, DA, TP, 1005	RC1005J103CS
158	R551	2007-000148	R-CHIP, 10Kohm, 5%, 1/16W, DA, TP, 1005	RC1005J103CS
159	R552	2007-000148	R-CHIP, 10Kohm, 5%, 1/16W, DA, TP, 1005	RC1005J103CS
160	R553	2007-000148	R-CHIP, 10Kohm, 5%, 1/16W, DA, TP, 1005	RC1005J103CS
161	R554	2007-000148	R-CHIP, 10Kohm, 5%, 1/16W, DA, TP, 1005	RC1005J103CS
162	R555	2007-000162	R-CHIP, 100Kohm, 5%, 1/16W, DA, TP, 1005	RC1005J104CS
163	R558	2007-007771	R-CHIP, 0ohm, 5%, 1/16W, DA, TP, 1005	RC1005J000CS
164	R560	2007-000148	R-CHIP, 10Kohm, 5%, 1/16W, DA, TP, 1005	RC1005J103CS

NO	Reference	SEC CODE	Part Description	Vendor Part No.
165	U100	2809-001237	OSCILLATOR-VCTCXO, 13MHz,5ppm,10Kohm//10pF,TP,3V,2mA	TCO-9131B 13MHz
166	U101	1203-001701	IC-VOLTAGE REGULATOR,SOT-23,5P	LP2982AIM5X-3.0
167	U102	1203-001454	IC-VOLTAGE REGULATOR, SOT-23, 5P, 59MIL	LP2981AIM5X-3.0
168	U103	1203-001454	IC-VOLTAGE REGULATOR, SOT-23, 5P, 59MIL	LP2981AIM5X-3.0
169	U104	2806-001210	VCO-DUAL 545MHZ,-,-,TP,2.85V,5MA	ENFVJ152S20
170	U105	1201-001583	IC-POWER AMP, 08109,QFP,16P,PLASTIC,8V,-30to+100C,	PF08109B-TL
171	U106	1209-001251	IC-Synthesizer, MTC20, 20P	LMX2336LSLBX
172	U107	2806-001224	OSCILLATOR-VCO(RX), 1167.5/1615MHz,0+-3dBm,TP,2.85V	ENFVF1B2SF7(ENFVZ4E76)
173	U303	1203-001204	IC-VOLTAGE REGULATOR, SOT-23, 5P, 59MIL	LP2981AIM5X-3.3
174	U305	1003-001226	IC-POWER DRIVER, SOP, 8P, 120MIL, SINGLE	D361A
175	U306	1203-001454	IC-VOLTAGE REGULATOR, SOT-23, 5P, 59MIL	LP2981AIM5X-3.0
176	U307	1203-001511	IC-RESET, 809, SOT-23, 3P, PLASTIC, 0.3/6.	MAX809REUR-T
177	U308	1203-001454	IC-VOLTAGE REGULATOR, SOT-23, 5P, 59MIL	LP2981AIM5X-3.0
178	U309	0506-001004	TR-ARRAY, NPN/PNP, 2.50V, 300mW, UM5	UMC5N
179	U311	1405-001018	Zener Diode, 14V, 1.6x0.8mm, TP	VC060314A300
180	U312	0504-001060	TR-DIGITAL, BCR08PN,NPN/PNP,250mW,2.2Kohm	BCR08PN
181	U313	1009-001006	HALL SWITCH	A3210ELH
182	U442	1203-001454	IC-VOLTAGE REGULATOR, SOT-23, 5P, 59MIL	LP2981AIM5X-3.0
183	U443	0504-001021	DTB113ZK,PNP,200MW,10K,SC-59,TP	DTB113ZK
184	U445	0504-000167	TR-DIGITAL, NPN, 100mW, 10K-10Kohm, SSM	DTC114EEA
185	U448	1106-001301	IC-4M SRAM+32M FLASH MEMORY,1337,262Kx1	LRS1337
186	U452	0801-002540	GATE	NC7SZ19
187	C103	N.C POINT		
188	C104	N.C POINT		
189	C115	N.C POINT		
190	C321	N.C POINT		
191	C553	N.C POINT		

SMD

NO	Reference	SEC CODE	Part Description	Vendor Part No.
1	SPK300	GH96-00908A	SPEAKER	
2	W200	GH39-00067A	SEMIRIGID CABLE	
3	CON1		LCD	

3-2 Main Parts List TOP

NO	Reference	SEC CODE	Part Description	Vendor Part No.
1	C141	2203-000628	C-CHIP, 22pF, 5%, 50V, TP, 1005	GRM36COG220J50PT
2	C144	2203-000254	C-CHIP, 10nF, 10%, 16V, TP, 1005	GRM36X7R103K16PT
3	C200	2203-000679	C-CHIP, 27pF, 5%, 50V, TP, 1005	GRM36COG270J50PT
4	C202	2301-001197	C-CHIP, 390pF,5%, 16V TP,2012	ECHU1H391JB5
5	C203	2301-001213	C-CHIP, 6.8nF, 5%, 16V, TP, 2012	ECHU1C682JB5
6	C204	2203-000812	C-CHIP, 33pF, 5%, 50V, TP, 1005	GRM36COG330J50PT
7	C205	2203-000438	C-CHIP, 1nF, 10%, 50V, TP, 1005	GRM36X7R102K50PT
8	C206	2203-000812	C-CHIP, 33pF, 5%, 50V, TP, 1005	GRM36COG330J50PT
9	C207	2203-000438	C-CHIP, 1nF, 10%, 50V, TP, 1005	GRM36X7R102K50PT
10	C208	2203-000812	C-CHIP, 33pF, 5%, 50V, TP, 1005	GRM36COG330J50PT
11	C209	2203-000438	C-CHIP, 1nF, 10%, 50V, TP, 1005	GRM36X7R102K50PT
12	C210	2203-000254	C-CHIP, 10nF, 10%, 16V, TP, 1005	GRM36X7R103K16PT
13	C211	2203-000438	C-CHIP, 1nF, 10%, 50V, TP, 1005	GRM36X7R102K50PT
14	C212	2203-000359	C-CHIP, 150pF, 5%, 50V, TP, 1005	GRM36COG151J50PT
15	C213	2203-005446	C-CHIP, 2.7pF, 0.25pF, 50V, NPO, TP, 1005	GRM36COG2R7C50PT
16	C214	2203-000550	C-CHIP, 20pF, 5%1005	GRM36COG200J50PT
17	C215	2203-000550	C-CHIP, 20pF, 5%1005	GRM36COG200J50PT
18	C217	2203-000812	C-CHIP, 33pF, 5%, 50V, TP, 1005	GRM36COG330J50PT
19	C218	2203-000836	C-CHIP, 390pF, 10%, 50V, TP, 1005	GRM36COG301J50PT
20	C219	2203-001239	C-CHIP, 82pF, 10%, 50V, TP, 1005	GRM36COG820J50PT
21	C220	2404-001017	CAP-TANTAL, 1uF,20%,10V,GP,TP,2012	TAJR105M010R
22	C221	2203-000438	C-CHIP, 1nF, 10%, 50V, TP, 1005	GRM36X7R102K50PT
23	C222	2203-000233	C-CHIP, 100pF, 5%, 50V, TP, 1005	GRM36COG101J50PT
24	C223	2203-000233	C-CHIP, 100pF, 5%, 50V, TP, 1005	GRM36COG101J50PT
25	C224	2203-005446	C-CHIP, 2.7pF, 0.25pF, 50V, NPO, TP, 1005	GRM36COG2R7C50PT
26	C225	2203-005446	C-CHIP, 2.7pF, 0.25pF, 50V, NPO, TP, 1005	GRM36COG2R7C50PT
27	C227	2203-000438	C-CHIP, 1nF, 10%, 50V, TP, 1005	GRM36X7R102K50PT
28	C229	2203-000438	C-CHIP, 1nF, 10%, 50V, TP, 1005	GRM36X7R102K50PT
29	C230	2203-000438	C-CHIP, 1nF, 10%, 50V, TP, 1005	GRM36X7R102K50PT
30	C231	2203-000679	C-CHIP, 27pF, 5%, 50V, TP, 1005	GRM36COG270J50PT
31	C232	2203-000679	C-CHIP, 27pF, 5%, 50V, TP, 1005	GRM36COG270J50PT
32	C233	2203-000425	C-CHIP, 18pF, 5%, 50V, TP, 1005	GRM36COG180J50PT
33	C234	2203-005234	C-CHIP, 1.2pF, 5%, 50V, TP, 1005	GRM36COG1R2C50PT
34	C235	2203-001201	C-CHIP, 7pF, 0.5pF, 50V, NPO, TP, 1005	GRM36COG070D50PT
35	C236	2203-000254	C-CHIP, 10nF, 10%, 16V, TP, 1005	GRM36X7R103K16PT
36	C237	2203-000233	C-CHIP, 100pF, 5%, 50V, TP, 1005	GRM36COG101J50PT
37	C238	2203-000254	C-CHIP, 10nF, 10%, 16V, TP, 1005	GRM36X7R103K16PT
38	C239	2203-000330	C-CHIP, 12pF, 5%, 50V, TP, 1005	GRM36COG120J50PT
39	C240	2203-000438	C-CHIP, 1nF, 10%, 50V, TP, 1005	GRM36X7R102K50PT
40	C241	2203-000628	C-CHIP, 22pF, 5%, 50V, TP, 1005	GRM36COG220J50PT

NO	Reference	SEC CODE	Part Description	Vendor Part No.
41	C243	2203-000628	C-CHIP, 22pF, 5%, 50V, TP, 1005	GRM36COG220J50PT
42	C244	2203-000425	C-CHIP, 18pF, 5%, 50V, TP, 1005	GRM36COG180J50PT
43	C246	2203-005061	C-CHIP, 100nF, +80-20%, 16V, TP, 1005	GRM36Y5V104Z16PT
44	C247	2203-001259	C-CHIP, 8pF, 0.5pF, 50V, TP, 1005	GRM36COG080D50PT
45	C249	2404-001210	C-TA, CHIP, 220uF, 20%	592D227X06R3U2T
46	C250	2203-005707	C-CHIP, 91pF, 10%, 50V, TP, 1005	GRM36COG910J50PT
47	C251	2203-000254	C-CHIP, 10nF, 10%, 16V, TP, 1005	GRM36X7R103K16PT
48	C252	2203-005707	C-CHIP, 91pF, 10%, 50V, TP, 1005	GRM36COG910J50PT
49	C253	2203-000836	C-CHIP, 390pF, 10%, 50V, TP, 1005	GRM36COG301J50PT
50	C255	2203-000233	C-CHIP, 100pF, 5%, 50V, TP, 1005	GRM36COG101J50PT
51	C256	2203-000696	C-CHIP, 2pF, 0.25pF, 50V, TP, 1005	GRM36COG020C50PT
52	C257	2203-000696	C-CHIP, 2pF, 0.25pF, 50V, TP, 1005	GRM36COG020C50PT
53	C258	2203-000679	C-CHIP, 27pF, 5%, 50V, TP, 1005	GRM36COG270J50PT
54	C259	2203-000696	C-CHIP, 2pF, 0.25pF, 50V, TP, 1005	GRM36COG020C50PT
55	C260	2203-000696	C-CHIP, 2pF, 0.25pF, 50V, TP, 1005	GRM36COG020C50PT
56	C261	2203-000438	C-CHIP, 1nF, 10%, 50V, TP, 1005	GRM36X7R102K50PT
57	C262	2203-000233	C-CHIP, 100pF, 5%, 50V, TP, 1005	GRM36COG101J50PT
58	C263	2203-000278	C-CHIP, 10pF, 5%, 50V, TP, 1005	GRM36COG050C50PT
59	C264	2203-000812	C-CHIP, 33pF, 5%, 50V, TP, 1005	GRM36COG330J50PT
60	C266	2203-000812	C-CHIP, 33pF, 5%, 50V, TP, 1005	GRM36COG330J50PT
61	C267	2203-000679	C-CHIP, 27pF, 5%, 50V, TP, 1005	GRM36COG270J50PT
62	C268	2203-000278	C-CHIP, 10pF, 5%, 50V, TP, 1005	GRM36COG050C50PT
63	C269	2203-000679	C-CHIP, 27pF, 5%, 50V, TP, 1005	GRM36COG270J50PT
64	C270	2203-000438	C-CHIP, 1nF, 10%, 50V, TP, 1005	GRM36X7R102K50PT
65	C317	2203-005061	C-CHIP, 100nF, +80-20%, 16V, TP, 1005	GRM36Y5V104Z16PT
66	C325	2203-000254	C-CHIP, 10nF, 10%, 16V, TP, 1005	GRM36X7R103K25PT
67	C354	2203-000254	C-CHIP, 10nF, 10%, 16V, TP, 1005	GRM36X7R103K25PT
68	C400	2203-000995	C-CHIP, 47pF, 10%, 50V, TP, 1005	GRM36COG470C50PT
69	C401	2203-000995	C-CHIP, 47pF, 10%, 50V, TP, 1005	GRM36COG470C50PT
70	C403	2203-005065	C-CHIP, 1uF, +80-20%, 10V, TP, 1608	GRM39Y5V105Z10PT
71	C404	2203-000870	C-CHIP, 3pF, 0.25pF, 50V, TP, 1005	GRM36COG030C50PT
72	C406	2404-001105	CAP-TANTAL, 10uF, 20%, 6.3V, 2012	TESVSPOJ106M8R
73	C407	2203-005061	C-CHIP, 100nF, +80-20%, 16V, TP, 1005	GRM36Y5V104Z16PT
74	C408	2404-001105	CAP-TANTAL, 10uF, 20%, 6.3V, 2012	TESVSPOJ106M8R
75	C409	2203-005061	C-CHIP, 100nF, +80-20%, 16V, TP, 1005	GRM36Y5V104Z16PT
76	C410	2404-000318	C-TA, CHIP, 6.8uF,20%,16V,-,TP,3528,-	TAJB685K016R
77	C411	2203-005065	C-CHIP, 1uF, +80-20%, 10V, TP, 1608	GRM39Y5V105Z10PT
78	C412	2203-005065	C-CHIP, 1uF, +80-20%, 10V, TP, 1608	GRM39Y5V105Z10PT
79	C413	2203-005065	C-CHIP, 1uF, +80-20%, 10V, TP, 1608	GRM39Y5V105Z10PT
80	C414	2203-005065	C-CHIP, 1uF, +80-20%, 10V, TP, 1608	GRM39Y5V105Z10PT
81	C415	2203-005065	C-CHIP, 1uF, +80-20%, 10V, TP, 1608	GRM39Y5V105Z10PT
82	C416	2203-005061	C-CHIP, 100nF, +80-20%, 16V, TP, 1005	GRM36Y5V104Z16PT

NO	Reference	SEC CODE	Part Description	Vendor Part No.
83	C417	2203-005065	C-CHIP, 1uF, +80-20%, 10V, TP, 1608	GRM39Y5V105Z10PT
84	C418	2203-001033	C-CHIP, 5.6nF, 10%, 25V, X7R, TP, 1005	GRM36X7R562K25PT
85	C419	2203-001033	C-CHIP, 5.6nF, 10%, 25V, X7R, TP, 1005	GRM36X7R562K25PT
86	C420	2203-001033	C-CHIP, 5.6nF, 10%, 25V, X7R, TP, 1005	GRM36X7R562K25PT
87	C421	2203-001033	C-CHIP, 5.6nF, 10%, 25V, X7R, TP, 1005	GRM36X7R562K25PT
88	C422	2203-005065	C-CHIP, 1uF, +80-20%, 10V, TP, 1608	GRM39Y5V105Z10PT
89	C425	2203-005065	C-CHIP, 1uF, +80-20%, 10V, TP, 1608	GRM39Y5V105Z10PT
90	C427	2203-005061	C-CHIP, 100nF, +80-20%, 16V, TP, 1005	GRM36Y5V104Z16PT
91	C432	2203-000254	C-CHIP, 10nF, 10%, 16V, TP, 1005	GRM36X7R103K25PT
92	C436	2404-001209	C-TA, CHIP, 100uF, 20%, 6.3V, TP	592D107X06R3T2T
93	C437	2203-000812	C-CHIP, 33pF, 5%, 50V, TP, 1005	GRM36COG330J50PT
94	C438	2203-000812	C-CHIP, 33pF, 5%, 50V, TP, 1005	GRM36COG330J50PT
95	C439	2203-000812	C-CHIP, 33pF, 5%, 50V, TP, 1005	GRM36COG330J50PT
96	C440	2203-000254	C-CHIP, 10nF, 10%, 16V, TP, 1005	GRM36X7R103K25PT
97	C441	2203-000812	C-CHIP, 33pF, 5%, 50V, TP, 1005	GRM36COG330J50PT
98	C442	2203-000812	C-CHIP, 33pF, 5%, 50V, TP, 1005	GRM36COG330J50PT
99	C443	2203-000812	C-CHIP, 33pF, 5%, 50V, TP, 1005	GRM36COG330J50PT
100	C444	2203-003054	C-CHIP, 9pF, 0.5pF, 50V, TP, 1005	GRM36COG090D50PT
101	C445	2203-003054	C-CHIP, 9pF, 0.5pF, 50V, TP, 1005	GRM36COG090D50PT
102	C446	2404-001162	Capacitor, 47uF,20%,4V,LZ,TP,3216	F950G476MAAJZTQ2
103	C448	2203-000812	C-CHIP, 33pF, 5%, 50V, TP, 1005	GRM36COG330J50PT
104	C449	2203-000254	C-CHIP, 10nF, 10%, 16V, TP, 1005	GRM36X7R103K25PT
105	C450	2203-000800	C-CHIP, 33nF, 10%, 16V, TP, 1608	GRM39X7R333K16PT
106	C451	2203-000800	C-CHIP, 33nF, 10%, 16V, TP, 1608	GRM39X7R333K16PT
107	C452	2203-000233	C-CHIP, 100pF, 5%, 50V, TP, 1005	GRM36COG101J50PT
108	C453	2203-000233	C-CHIP, 100pF, 5%, 50V, TP, 1005	GRM36COG101J50PT
109	C454	2203-000233	C-CHIP, 100pF, 5%, 50V, TP, 1005	GRM36COG101J50PT
110	C455	2203-000233	C-CHIP, 100pF, 5%, 50V, TP, 1005	GRM36COG101J50PT
111	C456	2203-005503	C-CHIP, 180pF, +80-20%, 25V, 1005	GRM36COG181J25PT
112	C457	2203-005503	C-CHIP, 180pF, +80-20%, 25V, 1005	GRM36COG181J25PT
113	C458	2203-005061	C-CHIP, 100nF, +80-20%, 16V, TP, 1005	GRM36Y5V104Z16PT
114	C459	2203-001432	C-CHIP, 47nF, 10%, 16V, TP, 1005	GRM36Y5V473K6PT
115	C460	2203-000812	C-CHIP, 33pF, 5%, 50V, TP, 1005	GRM36COG330J50PT
116	C461	2203-005061	C-CHIP, 100nF, +80-20%, 16V, TP, 1005	GRM36Y5V104Z16PT
117	C530	2203-005065	C-CHIP, 1uF, +80-20%, 10V, TP, 1608	GRM39Y5V105Z10PT
118	C539	2203-003054	C-CHIP, 9pF, 0.5pF, 50V, TP, 1005	GRM36COG090D50PT
119	C540	2203-000679	C-CHIP, 27pF, 5%, 50V, TP, 1005	GRM36COG270J50PT
120	C541	2203-005061	C-CHIP, 100nF, +80-20%, 16V, TP, 1005	GRM36Y5V104Z16PT
121	C542	2203-005061	C-CHIP, 100nF, +80-20%, 16V, TP, 1005	GRM36Y5V104Z16PT
122	C549	2203-005061	C-CHIP, 100nF, +80-20%, 16V, TP, 1005	GRM36Y5V104Z16PT
123	C550	2203-005061	C-CHIP, 100nF, +80-20%, 16V, TP, 1005	GRM36Y5V104Z16PT
124	C551	2203-005061	C-CHIP, 100nF, +80-20%, 16V, TP, 1005	GRM36Y5V104Z16PT

NO	Reference	SEC CODE	Part Description	Vendor Part No.
125	C556	2203-000679	C-CHIP, 27pF, 5%, 50V, TP, 1005	GRM36COG270J50PT
126	C557	2203-000679	C-CHIP, 27pF, 5%, 50V, TP, 1005	GRM36COG270J50PT
127	C558	2203-000679	C-CHIP, 27pF, 5%, 50V, TP, 1005	GRM36COG270J50PT
128	C559	2203-000679	C-CHIP, 27pF, 5%, 50V, TP, 1005	GRM36COG270J50PT
129	C560	2203-000679	C-CHIP, 27pF, 5%, 50V, TP, 1005	GRM36COG270J50PT
130	C561	2203-000679	C-CHIP, 27pF, 5%, 50V, TP, 1005	GRM36COG270J50PT
131	C562	2203-000679	C-CHIP, 27pF, 5%, 50V, TP, 1005	GRM36COG270J50PT
132	C563	2203-000679	C-CHIP, 27pF, 5%, 50V, TP, 1005	GRM36COG270J50PT
133	C565	2203-000679	C-CHIP, 27pF, 5%, 50V, TP, 1005	GRM36COG270J50PT
134	C568	2203-000679	C-CHIP, 27pF, 5%, 50V, TP, 1005	GRM36COG270J50PT
135	C569	2203-000679	C-CHIP, 27pF, 5%, 50V, TP, 1005	GRM36COG270J50PT
136	C570	2203-000679	C-CHIP, 27pF, 5%, 50V, TP, 1005	GRM36COG270J50PT
137	C571	2203-000679	C-CHIP, 27pF, 5%, 50V, TP, 1005	GRM36COG270J50PT
138	C572	2203-000679	C-CHIP, 27pF, 5%, 50V, TP, 1005	GRM36COG270J50PT
139	C573	2203-000679	C-CHIP, 27pF, 5%, 50V, TP, 1005	GRM36COG270J50PT
140	C576	2203-000679	C-CHIP, 27pF, 5%, 50V, TP, 1005	GRM36COG270J50PT
141	C577	2203-000679	C-CHIP, 27pF, 5%, 50V, TP, 1005	GRM36COG270J50PT
142	C580	2203-000330	C-CHIP, 12pF, 5%, 50V, TP, 1005	GRM36COG120J50PT
143	C581	2203-000330	C-CHIP, 12pF, 5%, 50V, TP, 1005	GRM36COG120J50PT
144	C583	2203-001124	C-CHIP, 680pF,10%,50V,X7R,TP,1005	CMO5X7R681K50PT
145	D401	0407-001002	DIODE-ARRAY, 80V, 300mA, CA2-3, EM3	DAN222
146	D402	0402-001331	DIODE-RECTIFIER, CRS04,40V,1A,S-FLAT,TP	CRS04(TE85L)
147	D403	0407-001002	DIODE-ARRAY, 80V, 300mA, CA2-3, EM3	DAN222
148	D303	0402-001329	DIODE-RECTIFIER, STPS140Z,40,1A,SOD-123,TP	STPS140Z
149	D406	0406-001083	ESD DIODE	ESDA6V1W5
150	D407	0406-001104	ESD DIODE	ESDA6V1-5W6
151	D408	0406-001104	ESD DIODE	ESDA6V1-5W6
152	D410	0402-001331	DIODE-RECTIFIER, CRS04,40V,1A,S-FLAT,TP	CRS04(TE85L)
153	D412	1405-001082	VARISTOR, 5.6V,20A,1x0.5x0.6mm,TP	VC040205X150
154	D413	1405-001082	VARISTOR, 5.6V,20A,1x0.5x0.6mm,TP	VC040205X150
155	D414	1405-001082	VARISTOR, 5.6V,20A,1x0.5x0.6mm,TP	VC040205X150
156	D417	0404-001102	DIODE ARRAY	HSMS-282M-TR1
157	D419	1405-001082	VARISTOR, 5.6V,20A,1x0.5x0.6mm,TP	VC040205X150
158	D420	1405-001082	VARISTOR, 5.6V,20A,1x0.5x0.6mm,TP	VC040205X150
159	D421	1405-001082	VARISTOR, 5.6V,20A,1x0.5x0.6mm,TP	VC040205X150
160	D422	1405-001082	VARISTOR, 5.6V,20A,1x0.5x0.6mm,TP	VC040205X150
161	D423	1405-001082	VARISTOR, 5.6V,20A,1x0.5x0.6mm,TP	VC040205X150
162	D427	0406-001083	ESD DIODE	ESDA6V1W5
163	D432	1405-001082	VARISTOR, 5.6V,20A,1x0.5x0.6mm,TP	
164	E200	2901-001116	FILTER-EMI, 50V, 300mA, 470pF, 2x1.25x0.5	NFM39R12C471T1M
165	F200	2904-001227	FILTER-SAW, 225MHz,0.26MHz,+/-67.5KHz/2dB,TP,5.5dB	B4833
166	F201	2904-001226	FILTER-SAW, 942.5MHz,35MHz,925-960MHz/2dB,TP,925-960MHz/3.8dB	B4121

NO	Reference	SEC CODE	Part Description	Vendor Part No.
167	F202	2904-001228	FILTER-SAW, 1.8425GHz,1805-1880MHz/1dB,TP,1805-1880MHz/3.5dB	B4133
168	F203	2904-001235	FILTER-SAW, 945MHZ,35MHZ,0.8DB/0.9DB,TP	FAR-G6CH-1G8425-L218
169	FB400	3301-001208	CORE-FERRITE BEAD, AB,1.6x0.8x0.8mm	BLM11P600SPT
170	FB401	3301-001208	CORE-FERRITE BEAD, AB,1.6x0.8x0.8mm	BLM11P600SPT
171	J400	3722-001380	EARPHONE JACK, 6P, 2.6PI, AG, BLK	02-787B2-53BKA
172	J401	3710-001302	IF CONNECTOR, 18P, 1R, 0.5mm, SMD-A, AUF	MQ179B-SAA-18P/4
173	J402	3709-001144	SIM CONNECTOR	1318723-6
174	J403	3710-001633	B'd CONNECTOR	AXK59302005
175	L200	2703-001685	Inductor, 82nH, 5%, 1608	0603HS-82NXJBC
176	L201	2703-001514	Inductor, 68nH, 5%, 1.8x1.12x1.02mm	0603CS-68NXJBC
177	L202	2703-001794	Inductor, 120nH,10%,1.6x0.8x0.8mm	0603HS-N12XJBC
178	L203	2703-001727	Inductor, 22nH, 5%, 1005	HK1005-22NJ-T
179	L204	2703-001726	Inductor, 27nH, 5%, 1005	HK1005-27NJ-T
180	L205	2703-001727	Inductor, 22nH, 5%, 1005	HK1005-22NJ-T
181	L206	2703-001727	Inductor, 22nH, 5%, 1005	HK1005-22NJ-T
182	L207	2703-001730	Inductor, 15nH, 5%, 1005	HK1005-15NJ-T
183	L208	2703-001798	Inductor, 2.2NH, 0.3NH, 1005	HK1005-2N2S
184	L209	2703-001786	Inductor, 10NH,1%,1.0X0.5X0.5MM	LL1005-FH10NJ
185	L210	2703-001735	Inductor, 3.9nH, 10%, 1005	HK1005-3N9K-T
186	L211	2703-001722	Inductor, 18nH, 5%, 1005	HK1005-18NJ-T
187	L212	2703-001545	Inductor, 47nH, 5%, 1608	0603HS-47NXJBC
188	L213	2703-001545	Inductor, 47nH, 5%, 1608	0603HS-47NXJBC
189	L214	2703-001735	Inductor, 3.9nH, 10%, 1005	HK1005-3N9K-T
190	L215	2703-001409	Inductor, 12nH, 10%, 1005	HK1005-12NK-T
191	L216	2703-001770	Inductor, 3.3NH,0.3NH,1.0X0.5X0.5MM	MLK1005S3N3ST
192	L217	2703-001730	Inductor, 15nH, 5%, 1005	HK1005-15NJ-T
193	L218	2703-001723	Inductor, 33nH, 5%, 1005	HK1005-33NJ-T
194	L219	2703-001723	Inductor, 33nH, 5%, 1005	HK1005-33NJ-T
195	L220	2703-001723	Inductor, 33nH, 5%, 1005	HK1005-33NJ-T
196	L400	2703-001740	Inductor, 10uH, 20%, 6.6x4.45x2.8	BDS-4020R-100M
197	L401	2703-002025	Inductor 47uH, 20%	BTC-0309-470
198	L402	2703-001409	Inductor, 12nH, 10%, 1005	HK1005-12NK-T
199	L404	2703-001752	Inductor, 39nH,5%,1.0x0.5x0.5mm	LL1005-FH39NJ
200	L406	2703-001752	Inductor, 39nH,5%,1.0x0.5x0.5mm	LL1005-FH39NJ
201	M400	3710-001105	CONNECTOR-SOCKET, 2P, 1R, 1.27mm, SMD-S	24-8005-002-000-007
202	Q200	0501-002096	TR-SMALL SIGNAL, NPN, 160mW, SOT343	BFP420
203	Q201	0501-002226	TR-SMALL SIGNAL, NPN,100MW,SOT-343	BFP520
204	Q400	0501-000218	TR-SMALL SIGNAL, NPN, 200mW, UMT	2SC4081
205	Q401	0505-001332	FET-SILICON, FDG6301, N, 0.22A, 4OHM, SC70-6	FDG6301N
207	R200	2007-000138	R-CHIP, 100ohm, 5%, 1/16W, DA, TP, 1005	ERJ2GEJ101X
208	R201	2007-007771	R-CHIP, 0ohm, 5%, 1/16W, DA, TP, 1005	RC1005J000CS
209	R202	2007-001301	R-CHIP, 68ohm, 5%, 1/16W, DA, TP, 1005	ERJ2GEJ680

NO	Reference	SEC CODE	Part Description	Vendor Part No.
210	R203	2007-001298	R-CHIP, 51ohm, 5%, 1/16W, DA, TP, 1005	ERJ2GEJ510
211	R204	2007-001298	R-CHIP, 51ohm, 5%, 1/16W, DA, TP, 1005	ERJ2GEJ510
212	R205	2007-000153	R-CHIP, 22Kohm, 5%, 1/16W, DA, TP, 1005	RC1005J223CS
213	R210	2007-007008	R-CHIP, 300ohm, 5%, 1/16W, DA, TP, 1005	RC1005J301CS
214	R211	2007-001288	R-CHIP, 18ohm, 5%, 1/16W, DA, TP, 1005	ERJ2GEJ180
215	R212	2007-007008	R-CHIP, 300ohm, 5%, 1/16W, DA, TP, 1005	RC1005J301CS
216	R213	2007-000138	R-CHIP, 100ohm, 5%, 1/16W, DA, TP, 1005	ERJ2GEJ101X
217	R214	2007-001307	R-CHIP, 180ohm, 5%, 1/16W, DA, TP, 1005	ERJ2GEJ181
218	R215	2007-000138	R-CHIP, 100ohm, 5%, 1/16W, DA, TP, 1005	ERJ2GEJ101X
219	R216	2007-007132	R-CHIP, 15Kohm, 1%, 1/16W, DA, TP, 1005	RK73H1ETP1502F
220	R218	2007-001307	R-CHIP, 180ohm, 5%, 1/16W, DA, TP, 1005	ERJ2GEJ181
221	R220	2007-000143	R-CHIP, 4.7Kohm, 5%, 1/16W, DA, TP, 1005	RC1005J472CS
222	R221	2007-001298	R-CHIP, 51ohm, 5%, 1/16W, DA, TP, 1005	ERJ2GEJ510
223	R222	2007-003030	R-CHIP, 91ohm, 5%, 1/16W, DA, TP, 1005	ERJ2GEJ910X
224	R223	2007-000141	R-CHIP, 2.2Kohm, 5%, 1/16W, DA, TP, 1005	ERJ2GEJ222X
225	R224	2007-000143	R-CHIP, 4.7Kohm, 5%, 1/16W, DA, TP, 1005	RC1005J472CS
226	R225	2007-007698	R-CHIP, 5.1Kohm, 1%, 1/16W, DA, TP, 1005	RK73H1ETP5101F
227	R226	2007-007139	R-CHIP, 47Kohm, 1%, 1/16W, DA, TP, 1005	MCRO1MZSF4702
228	R227	2007-007142	R-CHIP, 10Kohm, 1%, 1/16W, DA, TP, 1005	RK73H1ETD1002F
229	R228	2007-007311	R-CHIP, 22Kohm, 1%, 1/16W, DA, TP, 1005	RK73H1ETP2202F
230	R229	2007-007142	R-CHIP, 10Kohm, 1%, 1/16W, DA, TP, 1005	RK73H1ETD1002F
231	R230	2007-001301	R-CHIP, 68ohm, 5%, 1/16W, DA, TP, 1005	ERJ2GEJ680
232	R231	2007-003022	R-CHIP, 62ohm, 5%, 1/16W, DA, TP, 1005	TSR16GJ620V
233	R232	2007-003022	R-CHIP, 62ohm, 5%, 1/16W, DA, TP, 1005	TSR16GJ620V
234	R233	2007-007141	R-CHIP, 240ohm, 5%, 1/16W, DA, TP, 1005	ERJ2GEJ241X
235	R234	2007-001301	R-CHIP, 68ohm, 5%, 1/16W, DA, TP, 1005	ERJ2GEJ680
236	R235	2007-001306	R-CHIP, 150ohm, 5%, 1/16W, DA, TP, 1005	ERJ2GEJ151X
237	R236	2007-003030	R-CHIP, 91ohm, 5%, 1/16W, DA, TP, 1005	ERJ2GEJ910X
238	R238	2007-000148	R-CHIP, 10Kohm, 5%, 1/16W, DA, TP, 1005	RC1005J103CS
239	R240	2007-000148	R-CHIP, 10Kohm, 5%, 1/16W, DA, TP, 1005	RC1005J103CS
240	R241	2007-000148	R-CHIP, 10Kohm, 5%, 1/16W, DA, TP, 1005	RC1005J103CS
241	R307	2007-007590	R-CHIP, 82Kohm, 1%, 1/16W, DA, TP	RK73H1ETP8202F
242	R308	2007-007107	R-CHIP, 100Kohm, 1%, 1/16W, DA, TP, 1005	RK73H1ETD1003F
243	R312	2007-000148	R-CHIP, 10Kohm, 5%, 1/16W, DA, TP, 1005	RC1005J103CS
244	R348	2007-000148	R-CHIP, 10Kohm, 5%, 1/16W, DA, TP, 1005	RC1005J103CS
245	R401	2007-000982	R-CHIP, 5.6Kohm, 5%, 1/16W, DA, TP, 1005	ERJ2GEJ562X
246	R402	2007-000162	R-CHIP, 100Kohm, 5%, 1/16W, DA, TP, 1005	RC1005J104CS
247	R403	2007-007480	R-CHIP, 130Kohm, 1%, 1/16W, DA, TP, 1005	RK73H1ETP1303F
248	R404	2007-000162	R-CHIP, 100Kohm, 5%, 1/16W, DA, TP, 1005	RC1005J104CS
249	R405	2007-007981	R-CHIP, 180Kohm, 1%, 1/16W, DA, TP, 1005	RC1005J184CS
250	R407	2007-000170	R-CHIP, 1Mohm, 5%, 1/16W, DA, TP, 1005	ERJ2GEJ105X
251	R408	2007-000170	R-CHIP, 1Mohm, 5%, 1/16W, DA, TP, 1005	ERJ2GEJ105X

NO	Reference	SEC CODE	Part Description	Vendor Part No.
252	R409	2007-000170	R-CHIP, 1Mohm, 5%, 1/16W, DA, TP, 1005	ERJ2GEJ105X
253	R417	2007-007008	R-CHIP, 300ohm, 5%, 1/16W, DA, TP, 1005	RC1005J301CS
254	R418	2007-007470	R-CHIP, 7.5Kohm,1%,1/16W,DA,TP,1005	ERJ2GEJ752X
255	R419	2007-000140	R-CHIP, 1Kohm, 5%, 1/16W, DA, TP, 1005	ERJ2GEJ102X
256	R420	2007-000148	R-CHIP, 10Kohm, 5%, 1/16W, DA, TP, 1005	RC1005J103CS
257	R422	2007-000162	R-CHIP, 100Kohm, 5%, 1/16W, DA, TP, 1005	RC1005J104CS
258	R423	2007-000162	R-CHIP, 100Kohm, 5%, 1/16W, DA, TP, 1005	RC1005J104CS
259	R424	2007-000148	R-CHIP, 10Kohm, 5%, 1/16W, DA, TP, 1005	RC1005J103CS
260	R426	2007-003008	R-CHIP, 200ohm, 5%, 1/16W, DA, TP, 1005	ERJ2GEJ200X
262	R427	2007-000148	R-CHIP, 10Kohm, 5%, 1/16W, DA, TP, 1005	RC1005J103CS
263	R429	2007-000152	R-CHIP, 20Kohm, 5%, 1/16W, DA, TP, 1005	RC1005J203CS
264	R432	2007-000162	R-CHIP, 100Kohm, 5%, 1/16W, DA, TP, 1005	RC1005J104CS
265	R433	2007-000141	R-CHIP, 2.2Kohm, 5%, 1/16W, DA, TP, 1005	ERJ2GEJ222X
266	R434	2007-000141	R-CHIP, 2.2Kohm, 5%, 1/16W, DA, TP, 1005	ERJ2GEJ222X
267	R435	2007-000148	R-CHIP, 10Kohm, 5%, 1/16W, DA, TP, 1005	RC1005J103CS
268	R437	2007-000162	R-CHIP, 100Kohm, 5%, 1/16W, DA, TP, 1005	RC1005J104CS
269	R438	2007-000148	R-CHIP, 10Kohm, 5%, 1/16W, DA, TP, 1005	RC1005J103CS
270	R439	2007-000162	R-CHIP, 100Kohm, 5%, 1/16W, DA, TP, 1005	RC1005J104CS
271	R440	2007-000168	R-CHIP, 470Kohm, 5%, 1/16W, DA, TP, 1005	ERJ2GEJ474X
272	R441	2007-000157	R-CHIP, 47Kohm, 5%, 1/16W, DA, TP, 1005	RC1005J473CS
273	R442	2007-000157	R-CHIP, 47Kohm, 5%, 1/16W, DA, TP, 1005	RC1005J473CS
274	R443	2007-000157	R-CHIP, 47Kohm, 5%, 1/16W, DA, TP, 1005	RC1005J473CS
275	R444	2007-000139	R-CHIP, 220ohm, 5%, 1/16W, DA, TP, 1005	ERJ2GE221X
276	R445	2007-002796	R-CHIP, 510ohm, 5%, 1/16W, DA, TP, 1005	ERJ2GEJ511X
277	R446	2007-002796	R-CHIP, 510ohm, 5%, 1/16W, DA, TP, 1005	ERJ2GEJ511X
278	R447	2007-000139	R-CHIP, 220ohm, 5%, 1/16W, DA, TP, 1005	ERJ2GE221X
279	R449	2011-001345	R-NETWORK, 10Kohm,5%,1/16W,L,CHIP,8P,TP	EXB28V103JX
280	R450	2007-000148	R-CHIP, 10Kohm, 5%, 1/16W, DA, TP, 1005	RC1005J103CS
281	R452	2007-007317	R-CHIP, 2.2Kohm, 1%, 1/16W, DA, TP, 1005	RK73H1ETP2201F
282	R453	2007-007317	R-CHIP, 2.2Kohm, 1%, 1/16W, DA, TP, 1005	RK73H1ETP2201F
283	R454	2007-007317	R-CHIP, 2.2Kohm, 1%, 1/16W, DA, TP, 1005	RK73H1ETP2201F
284	R455	2007-007317	R-CHIP, 2.2Kohm, 1%, 1/16W, DA, TP, 1005	RK73H1ETP2201F
285	R456	2007-007318	R-CHIP, 1Kohm, 1%, 1/16W, DA, TP, 1005	RK73H1ETP1001F
286	R457	2007-007318	R-CHIP, 1Kohm, 1%, 1/16W, DA, TP, 1005	RK73H1ETP1001F
287	R458	2007-007318	R-CHIP, 1Kohm, 1%, 1/16W, DA, TP, 1005	RK73H1ETP1001F
288	R459	2007-007318	R-CHIP, 1Kohm, 1%, 1/16W, DA, TP, 1005	RK73H1ETP1001F
289	R460	2007-000162	R-CHIP, 100Kohm, 5%, 1/16W, DA, TP, 1005	RC1005J104CS
290	R461	2007-000148	R-CHIP, 10Kohm, 5%, 1/16W, DA, TP, 1005	RC1005J103CS
291	R462	2007-000159	R-CHIP, 56Kohm, 5%, 1/16W, DA, TP, 1005	RC1005J563CS
292	R526	2007-000148	R-CHIP, 10Kohm, 5%, 1/16W, DA, TP, 1005	RC1005J103CS
293	R528	2007-000138	R-CHIP, 100ohm, 5%, 1/16W, DA, TP, 1005	ERJ2GEJ101X
294	R529	2007-000138	R-CHIP, 100ohm, 5%, 1/16W, DA, TP, 1005	ERJ2GEJ101X

NO	Reference	SEC CODE	Part Description	Vendor Part No.
295	R530	2007-000138	R-CHIP, 100ohm, 5%, 1/16W, DA, TP, 1005	ERJ2GEJ101X
296	R533	2007-000162	R-CHIP, 100Kohm, 5%, 1/16W, DA, TP, 1005	RC1005J104CS
297	R535	2007-000148	R-CHIP, 10Kohm, 5%, 1/16W, DA, TP, 1005	RC1005J103CS
298	R536	2007-000162	R-CHIP, 100Kohm, 5%, 1/16W, DA, TP, 1005	RC1005J104CS
299	R537	2007-000162	R-CHIP, 100Kohm, 5%, 1/16W, DA, TP, 1005	RC1005J104CS
300	R538	2007-000162	R-CHIP, 100Kohm, 5%, 1/16W, DA, TP, 1005	RC1005J104CS
301	R539	2007-000162	R-CHIP, 100Kohm, 5%, 1/16W, DA, TP, 1005	RC1005J104CS
302	R540	2007-000162	R-CHIP, 100Kohm, 5%, 1/16W, DA, TP, 1005	RC1005J104CS
303	R546	2007-000162	R-CHIP, 100Kohm, 5%, 1/16W, DA, TP, 1005	RC1005J104CS
304	R547	2007-000162	R-CHIP, 100Kohm, 5%, 1/16W, DA, TP, 1005	RC1005J104CS
305	R556	2007-000162	R-CHIP, 100Kohm, 5%, 1/16W, DA, TP, 1005	RC1005J104CS
306	R559	2007-007771	R-CHIP, 0ohm, 5%, 1/16W, DA, TP, 1005	RC1005J000CS
307	R561	2007-007592	R-CHIP, 270Kohm, 1%, 1/16W, DA, TP, 1005	RK73H1ETP2703F
308	R562	2007-007135	R-CHIP, 18Kohm, 1%, 1/16W, DA, TP, 1005	RK73H1ETP1802F
309	R563	2007-007309	R-CHIP, 12Kohm, 1%, 1/16W, DA, TP, 1005	RK73H1ETP1202F
310	R564	2007-007309	R-CHIP, 12Kohm, 1%, 1/16W, DA, TP, 1005	RC1005J104CS
311	TH400	1404-001005	THERMISTOR, 47Kohm, 5%, 4050K, 2.0mW/C, TP	NTH5G40B473
312	U200	2806-001239	VCO	VOF1748C28KRF
313	U201	1205-001653	IC-TRANSCEIVER, QFP, 48P, 4V, 400MW, TR	HD155121F
314	U204	0504-001060	TR-DIGITAL, BCR08PN,NPN/PNP,250mW,2.2Kohm	BCRO89N
315	U205	1209-001292	IC-APC, QFP,24P,165MIL,3.6V,240mW,-25to+85C,TP	HD155171NP01EL
316	U206	4709-001214	COUPLER-DIRECTION, 880-915MHz,19.5+-1dB,13dB,2.0X1.25X0.7mm,TP	DCS214E-0897TR
317	U207	4709-001213	COUPLER-DIRECTION, 1710-1785MHz,14+-1dB,12dB,2.0X1.25X0.7mm,TP	DCS214E-1747TR
318	U208	2909-001086	FILTER-DUPLEXER 942.5MHZ,897.5MHZ,1.1/1.	SHS-L090D
319	U209	0504-001012	TR-DIGITAL, NPN, 150mW, 10K-47Kohm, EMT	DTC114YETL
320	U210	0504-001060	TR-DIGITAL, BCR08PN,NPN/PNP,250mW,2.2Kohm	BCRO89N
321	U211	0504-001060	TR-DIGITAL, BCR08PN,NPN/PNP,250mW,2.2Kohm	BCRO89N
322	U304	1103-001184	24C256,32Kx8Bit,dBGA,8P,92MIL,-.27V TR	AT24C256-10UI-2.7-T.R
323	U400	0504-001012	TR-DIGITAL, NPN, 150mW, 10K-47Kohm, EMT	DTC114YETL
324	U401	1202-001022	IC-VOLFAGECOMP, 8P, DUAL, 36V, CMOS	TC75W56FU
325	U409	0504-000168	TR-DIGITAL, NPN, 100mW, 47K-47Kohm, SSM	DTC144EEA
326	U410	1203-001702	IC-DC/DC CONVERTER, 1676, SOP, 10P, 112MIL	MAX1676EUB-T
327	U412	0504-001060	TR-DIGITAL, BCR08PN,NPN/PNP,250mW,2.2Kohm	BCRO89N
328	U413	1001-001145	ANALOG SWITCH	MAX4599
329	U414	1205-001881	ONE C	VP40575
330	U415	1001-001145	ANALOG SWITCH	MAX4599
332	U446	0504-000168	TR-DIGITAL, NPN, 100mW, 47K-47Kohm, SSM	DTC144EEA
333	U447	0801-002510	VOLFAGECOMP,DUAL, 36V, CMOS	TC7W74FK
334	U451	0801-002345	IC-CMOS LOGIC, 7S04FU,INVERTER,SOP,5P,TP,	TC7S04FU
335	U454	0504-000168	TR-DIGITAL, NPN, 100mW, 47K-47Kohm, SSM	DTC144EEA
336	X400	2801-003856	CRYSTAL, 32.768KHz, 30ppm, 9pF	MC-146
337	C201	N.C POINT		

NO	Reference	SEC CODE	Part Description	Vendor Part No.
338	C216	N.C POINT		
339	C226	N.C POINT		
340	C228	N.C POINT		
341	C242	N.C POINT		
342	C245	N.C POINT		
343	C248	N.C POINT		
344	C447	N.C POINT		
345	C543	N.C POINT		
346	C544	N.C POINT		
347	C566	N.C POINT		
348	C567	N.C POINT		
349	C582	N.C POINT		
350	R219	N.C POINT		
351	R237	N.C POINT		
352	R436	N.C POINT		
353	R448	N.C POINT		
354	L221	N.C POINT		

4. Block Diagrams

4-1 Main Base Band

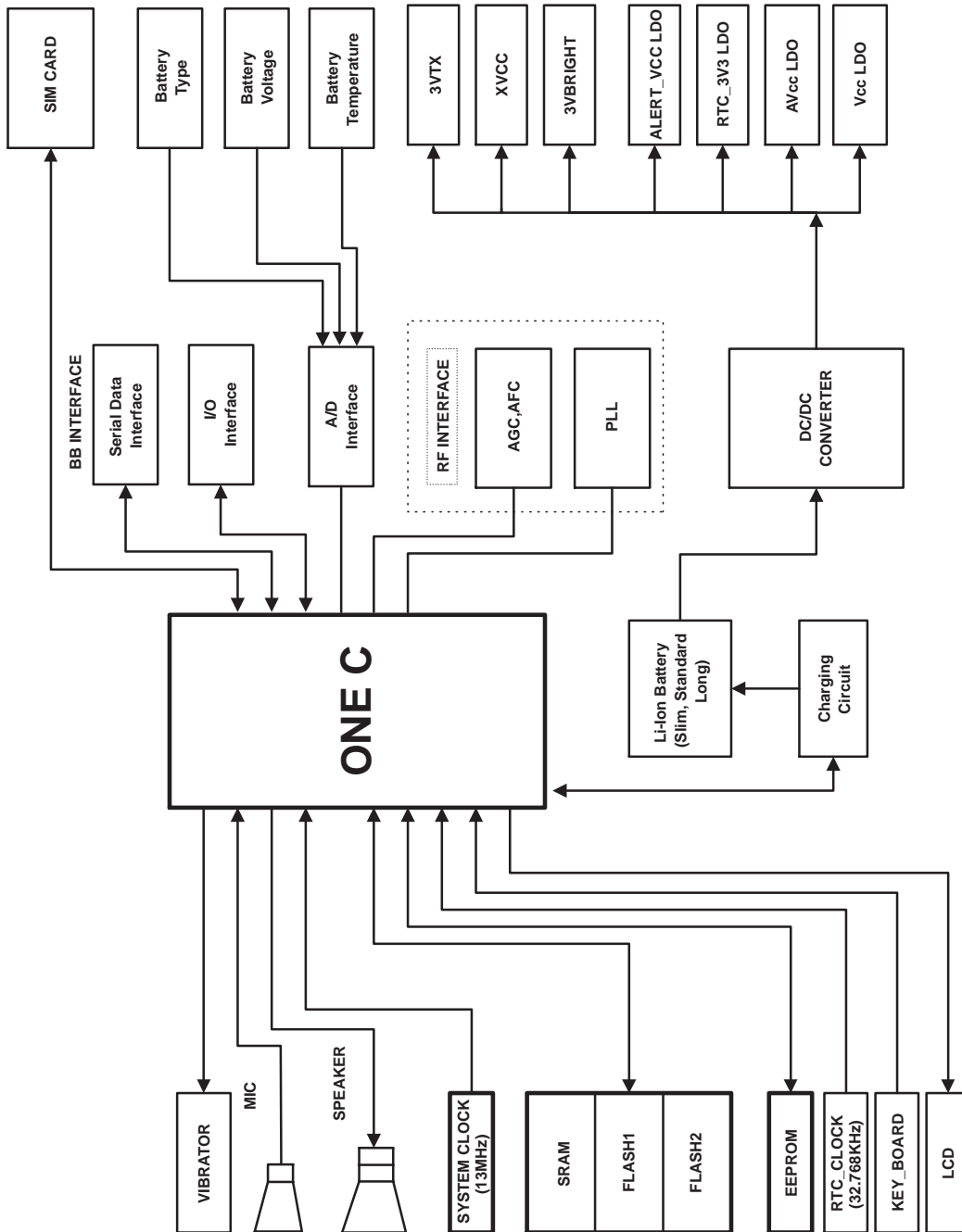

4-2 Main RF

Main RF Block Diagram

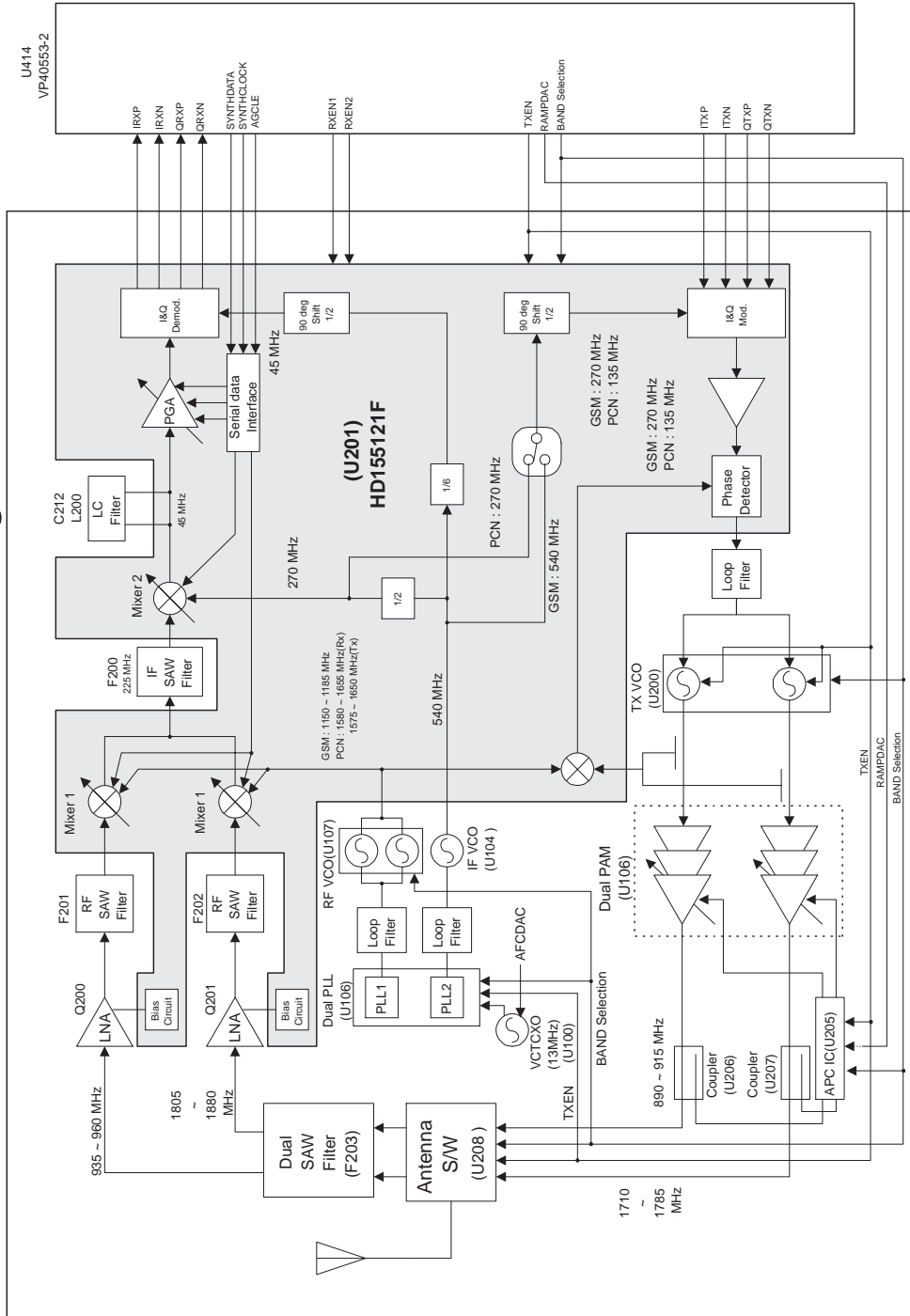

5. Flow chart of trouble shooting

5-1 Power ON

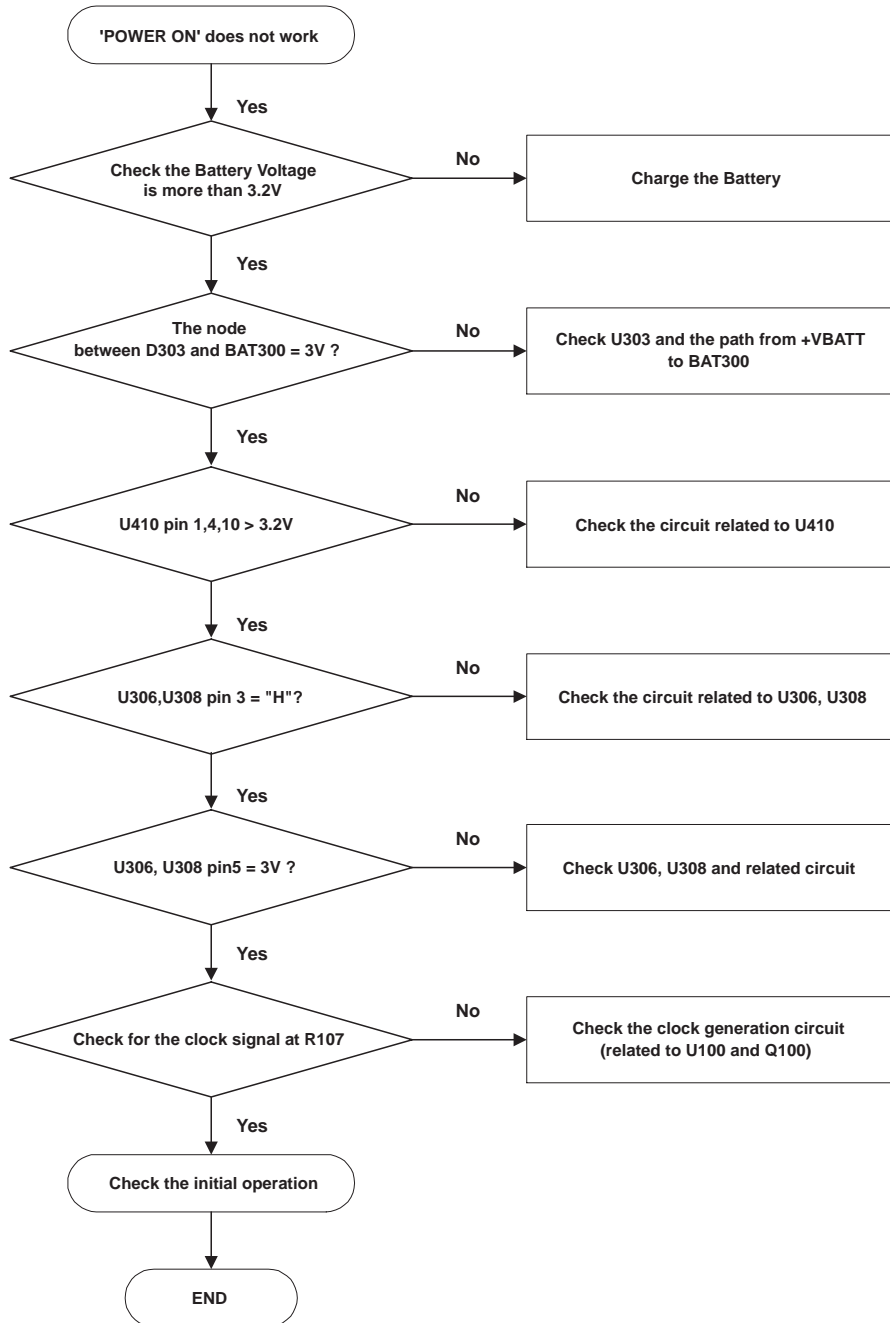

5-2 Initial

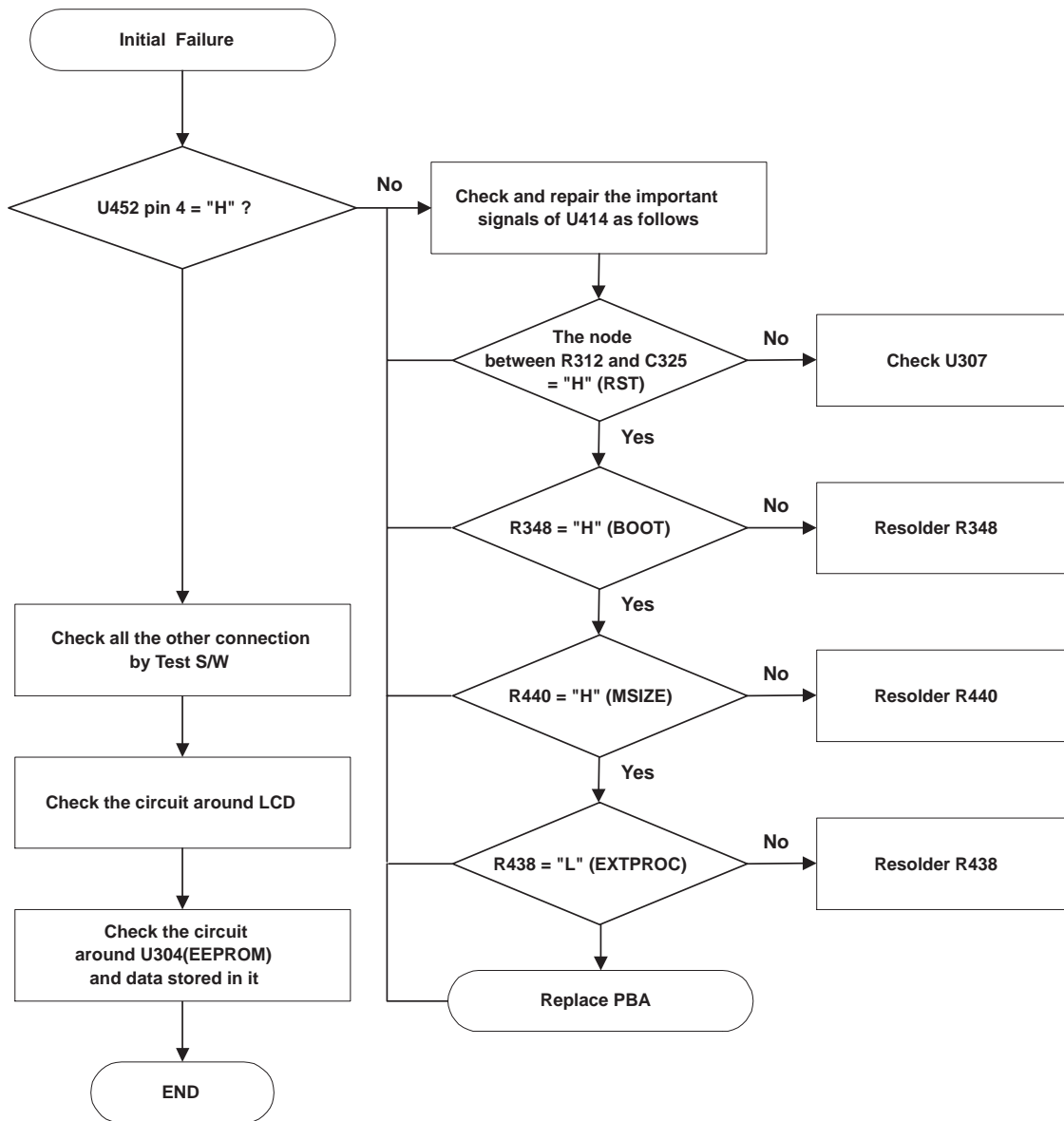

5-3 Charging Part

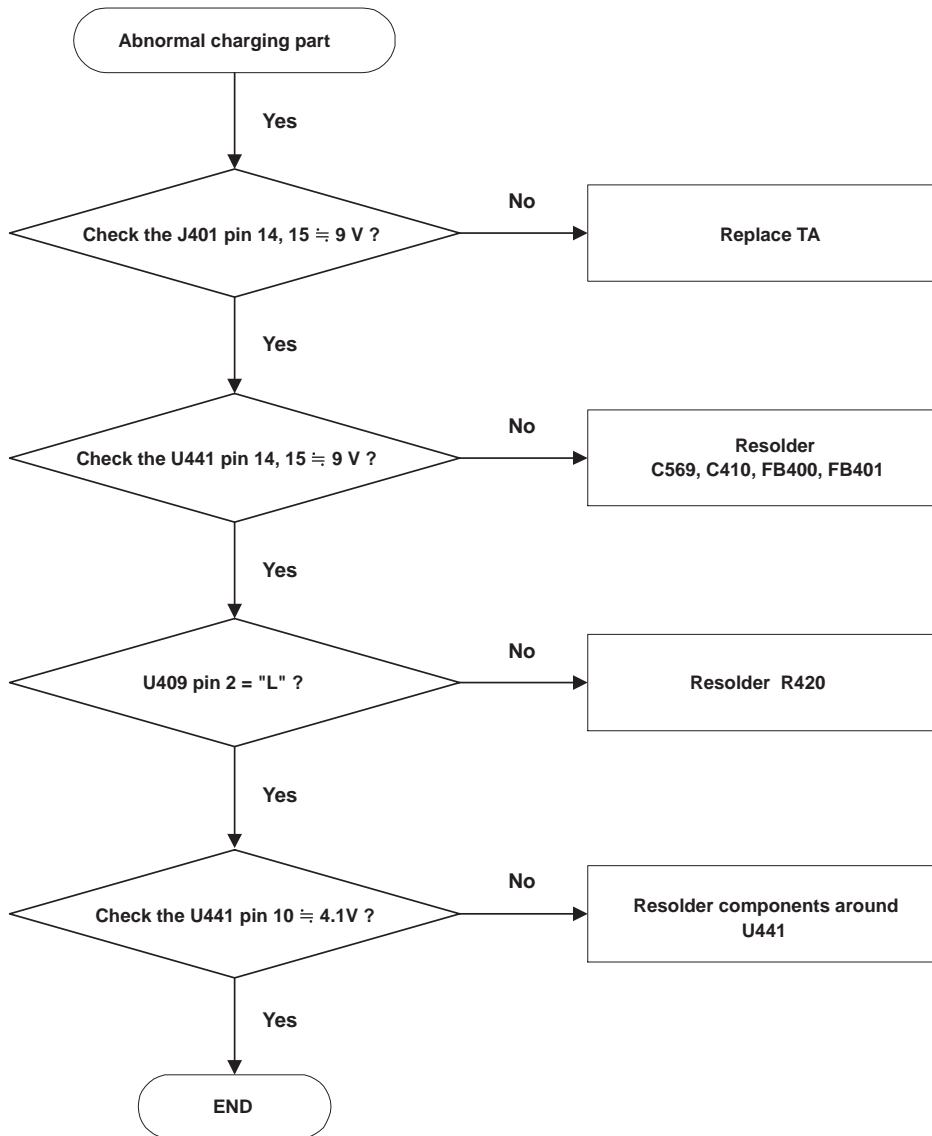

5-4 Sim Part

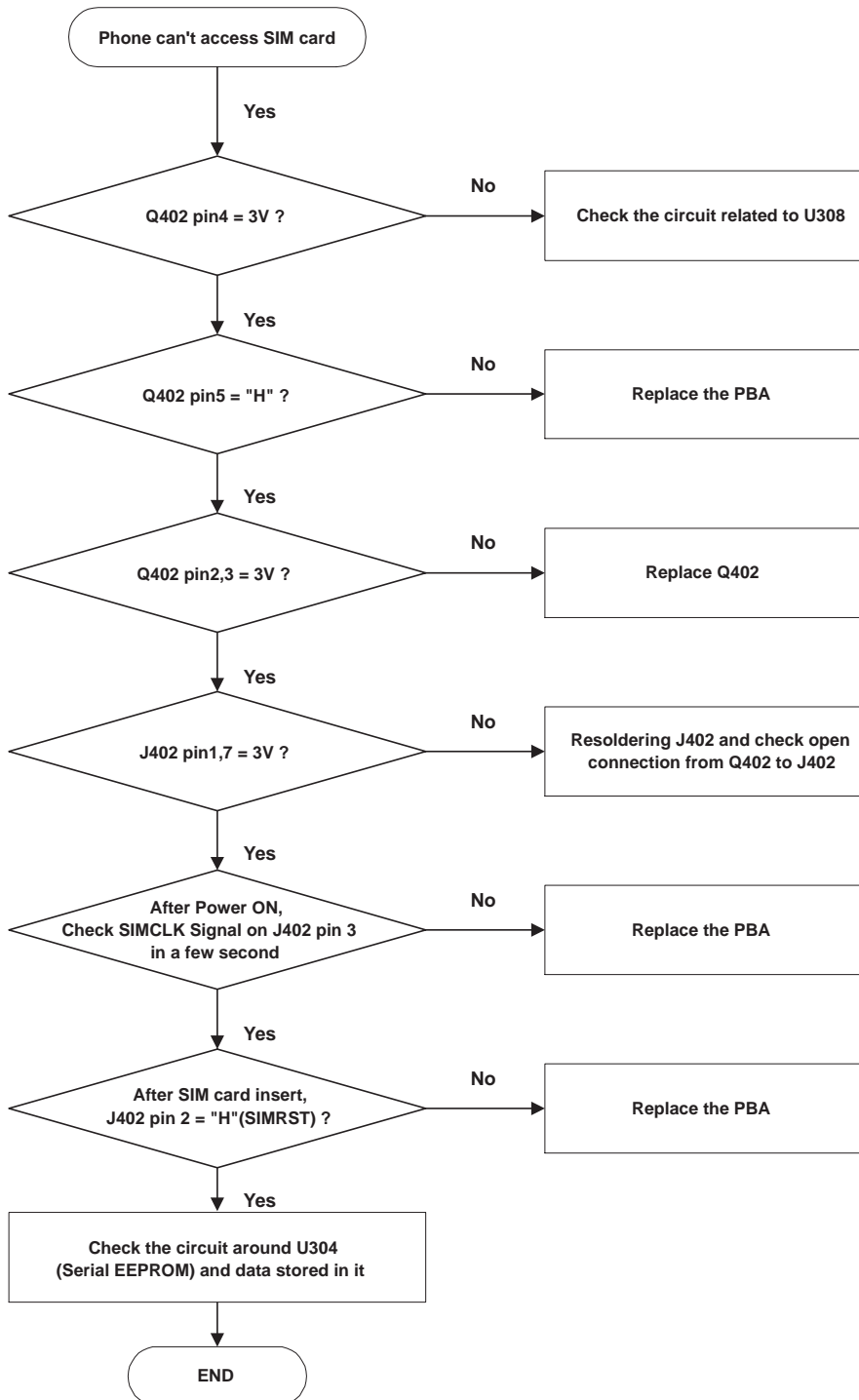

5-5 Microphone Part

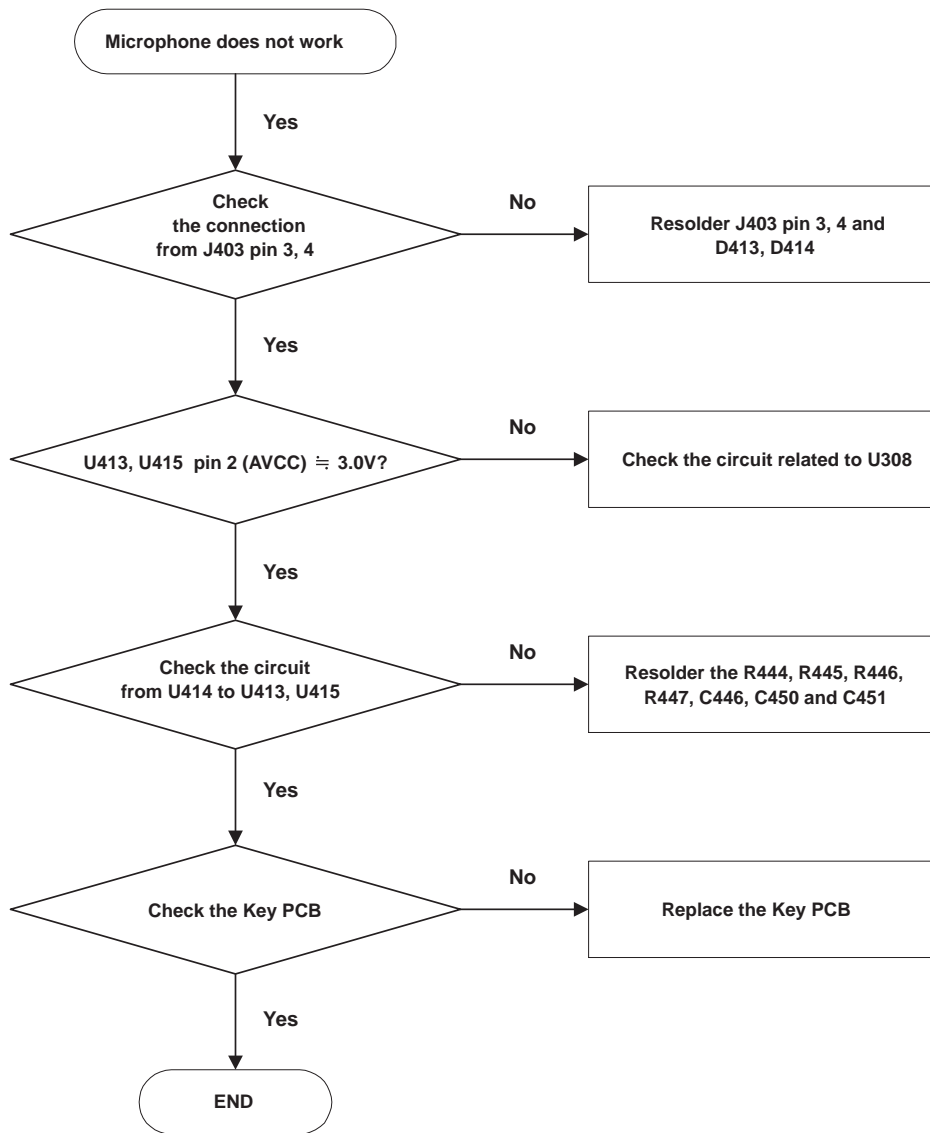

5-6 Speaker Part

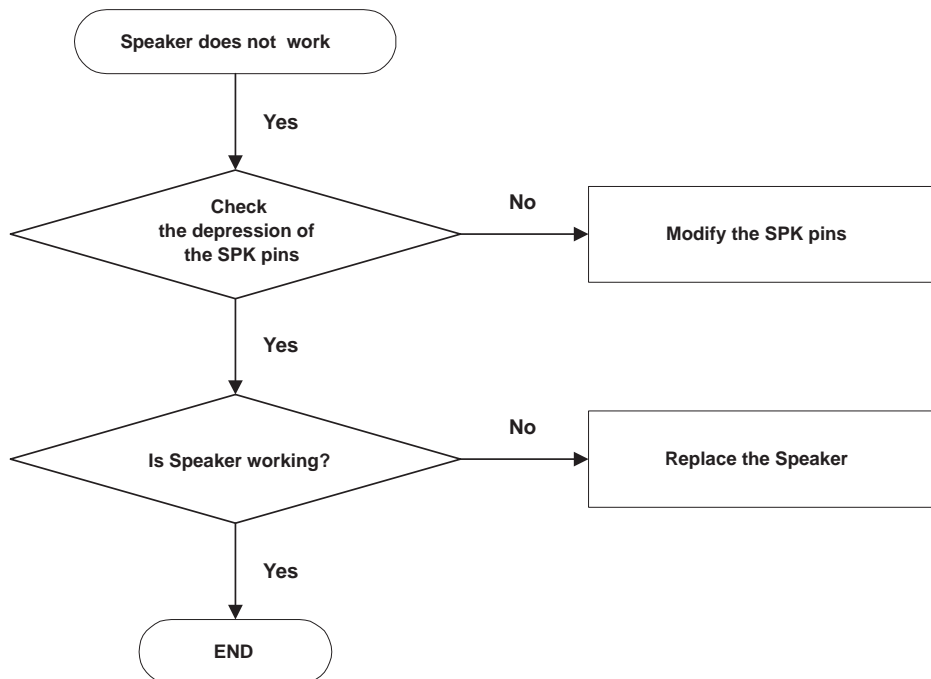

5-7 Key Data Input

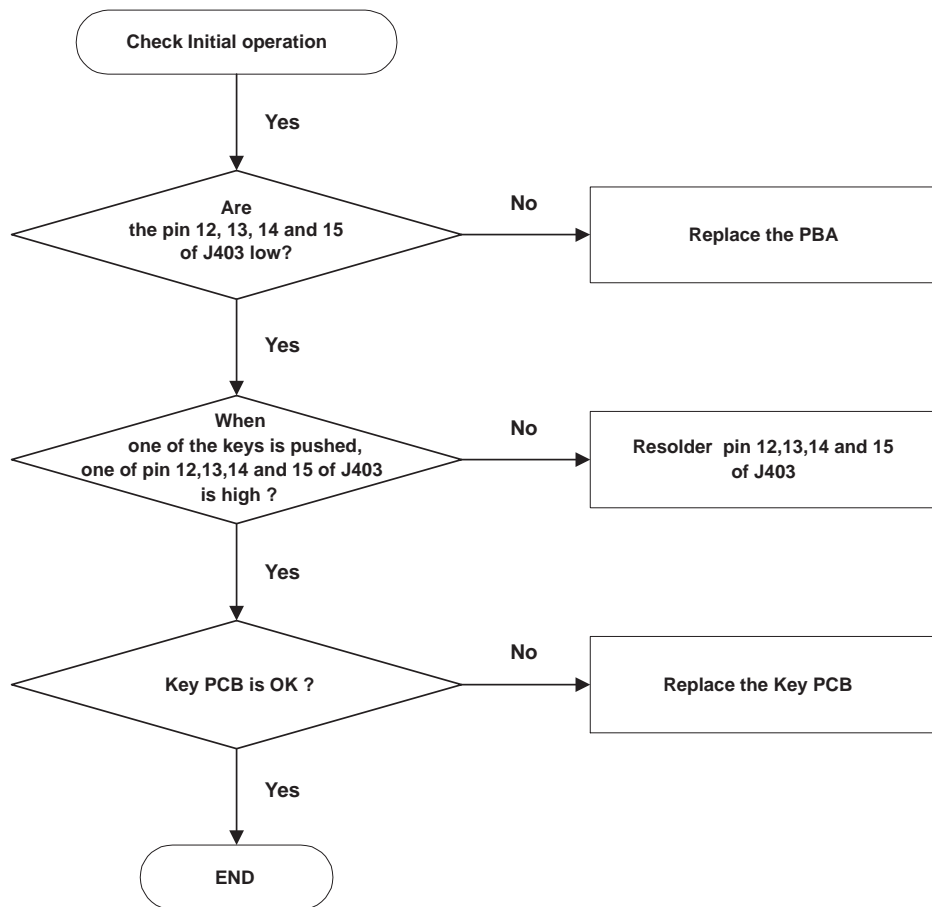

5-8 Alert tone

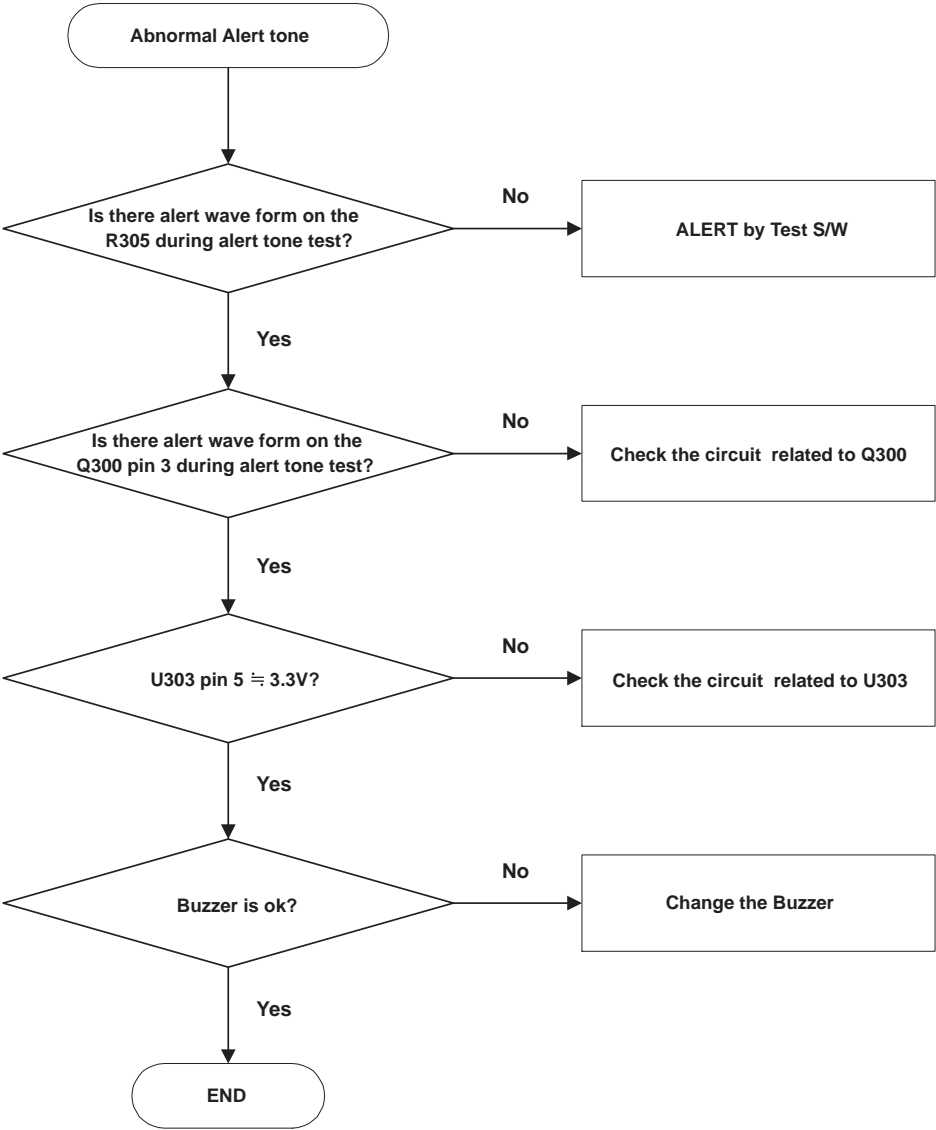

5-9 Ring Indicator

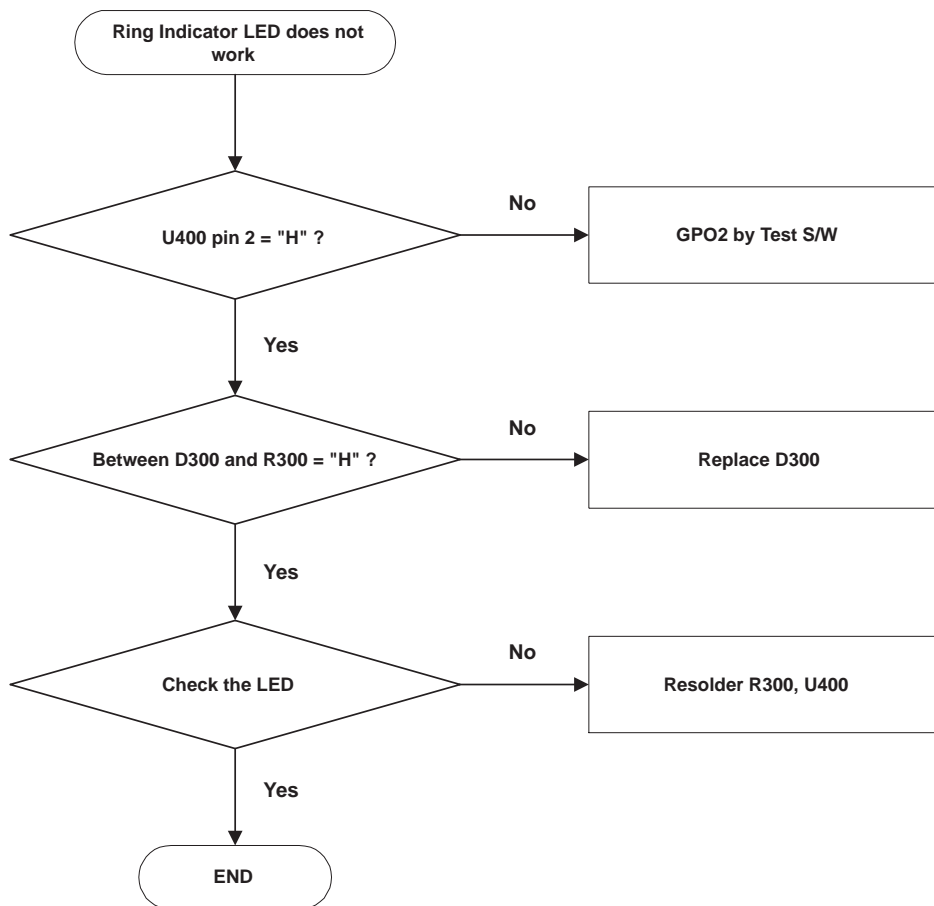

5-10 Back Light

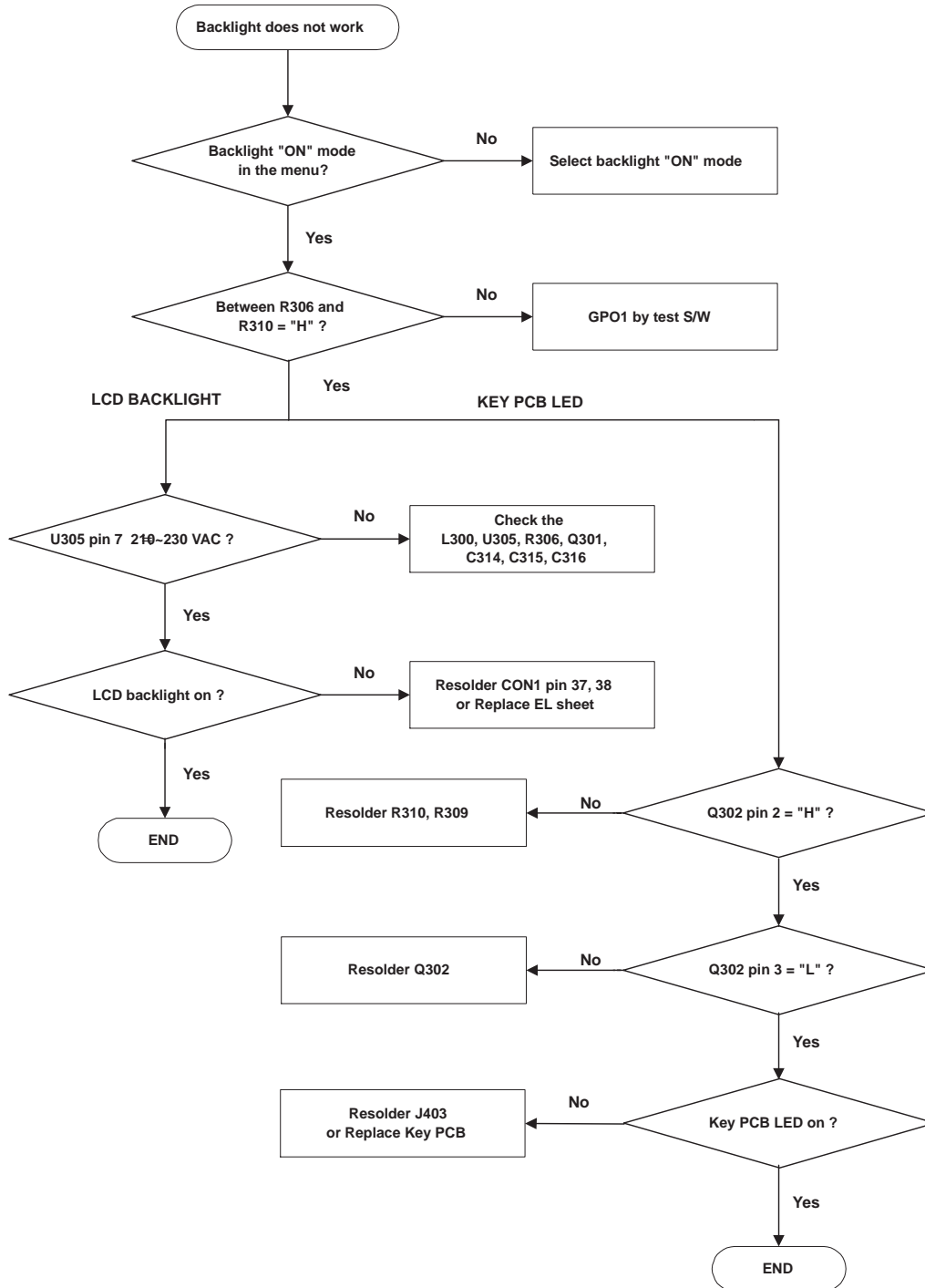

5-11 GSM Receiver

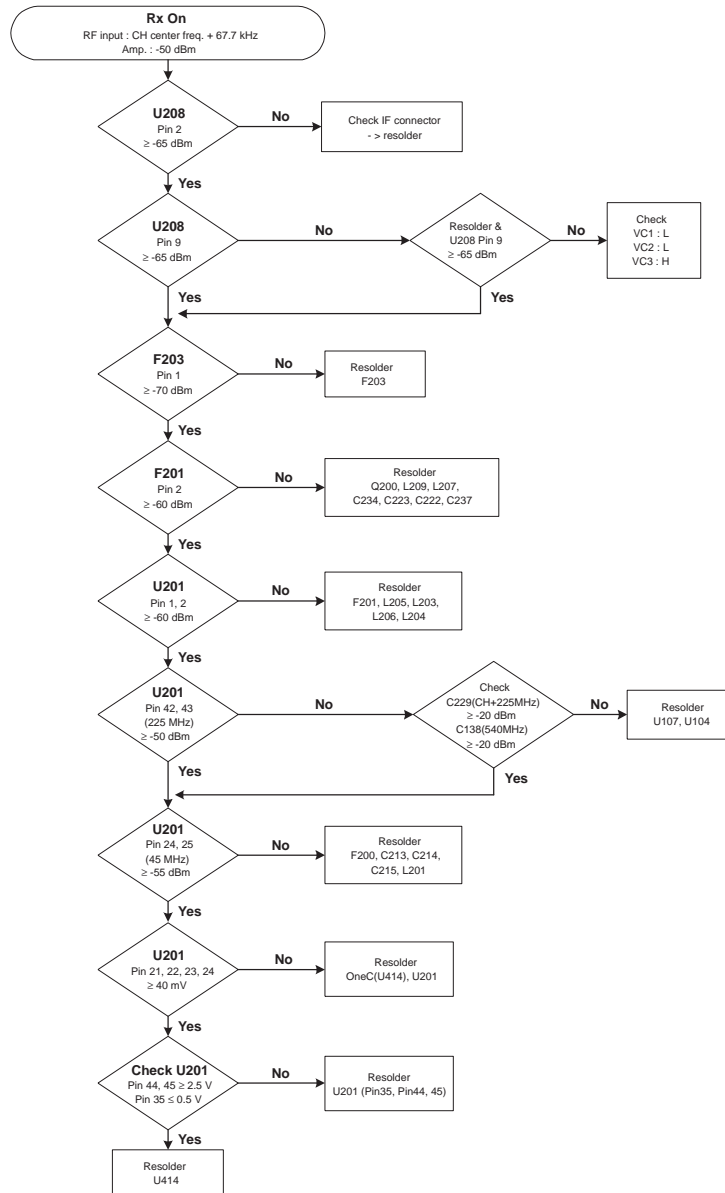

5-12 GSM Transmit

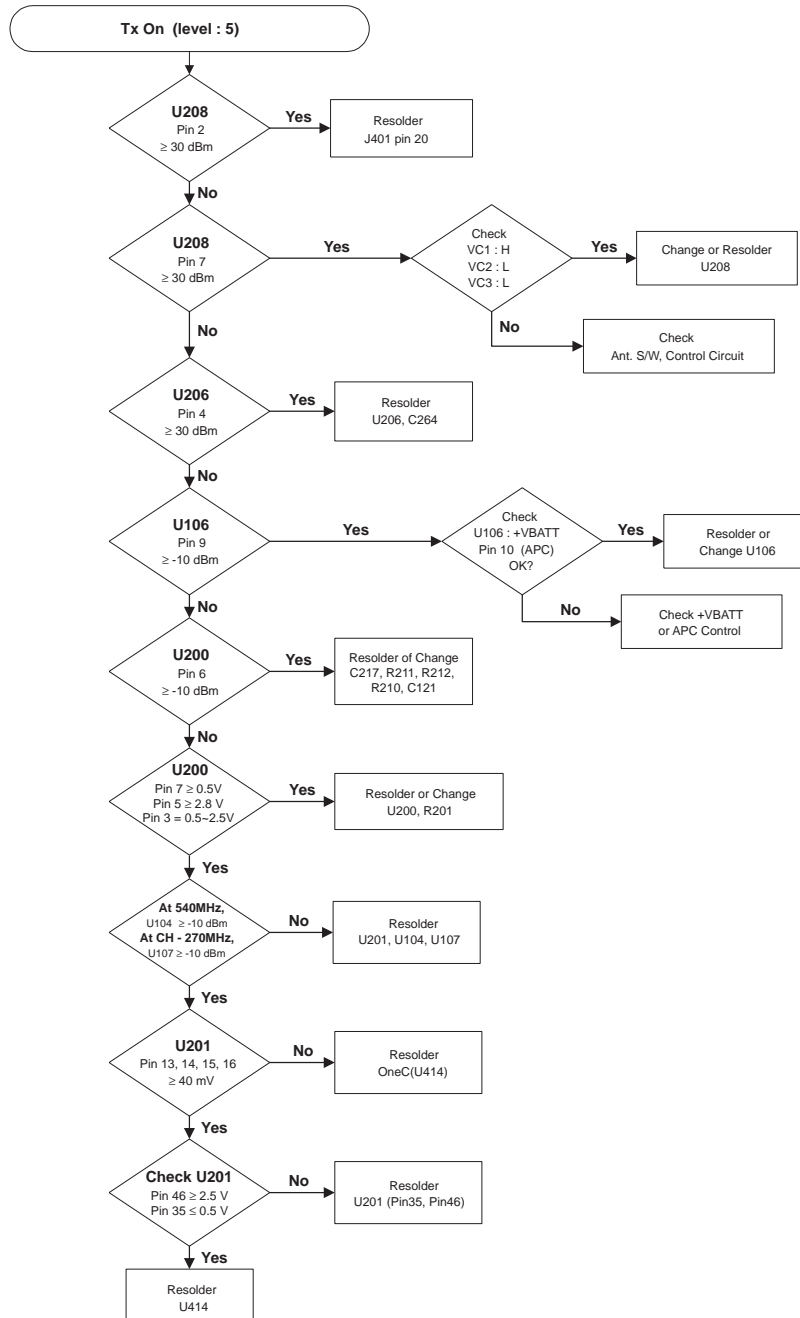

5-13 DCS Receiver

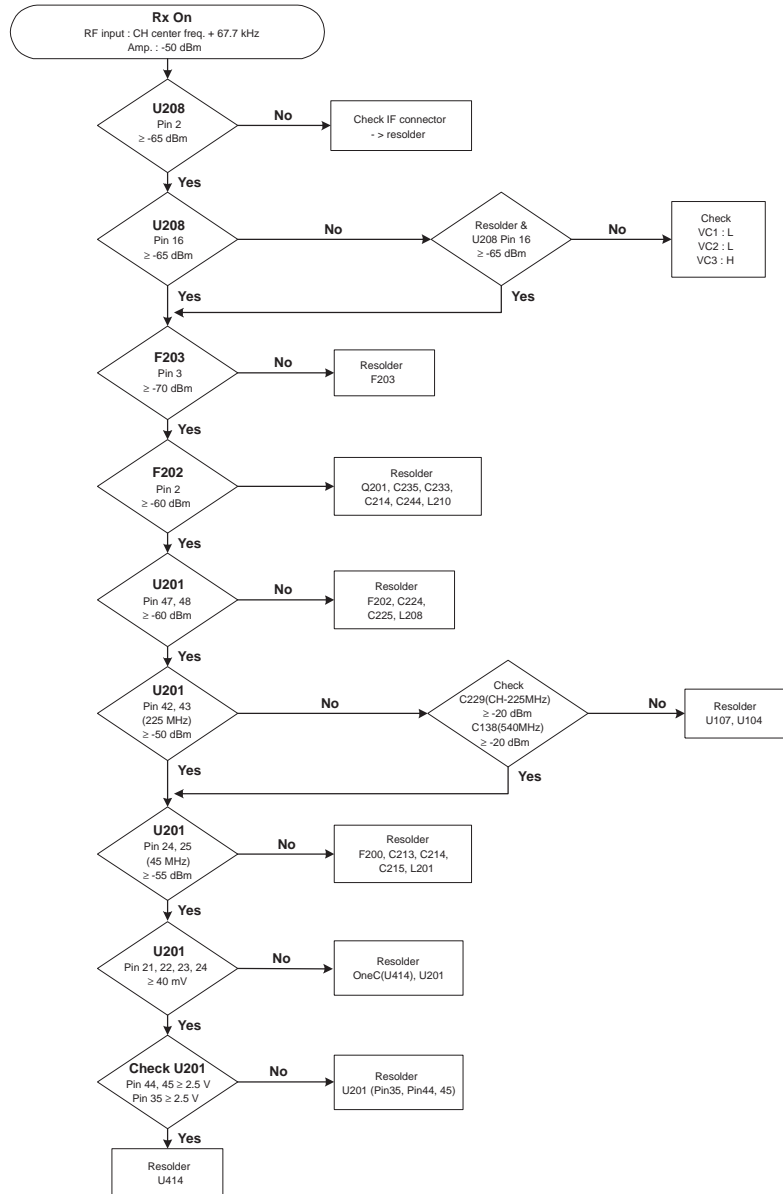

5-14 DCS Transmit

